

## STO 15 ZZ TORRINGTON

Yoke type track roller

TYPE: Roller bearings, Yoke type track rollers, Without axial guidance, Outer ring without ribs, shields 2Z, With an inner ring

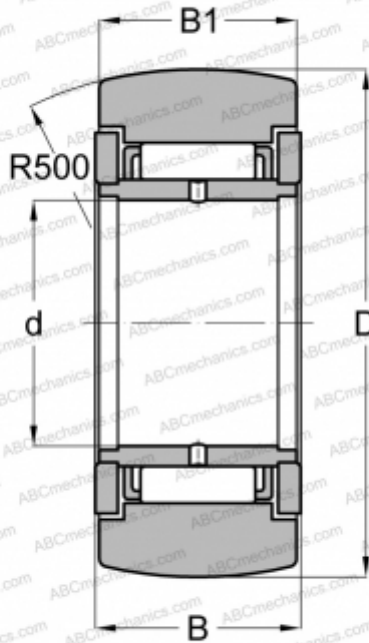

### Technical specification

#### DIMENSIONS, MM

d	15,000
D	35,000
B	16,000
B1	15,800

#### WEIGHT, KG

0,091

#### MANUFACTURER

[TORRINGTON](#)

#### INTERCHANGE

ABC	<a href="#">STO 15 ZZ</a>
FAG	<a href="#">STO 15 2Z(NAST 15 2Z)</a>
SKF	<a href="#">NAST 15 2Z</a>
IKO	<a href="#">NAST 15 ZZR</a>