

## NAST 17 2Z SKF

Yoke type track roller

TYPE: Roller bearings, Yoke type track rollers, Without axial guidance, Outer ring without ribs, shields 2Z, With an inner ring

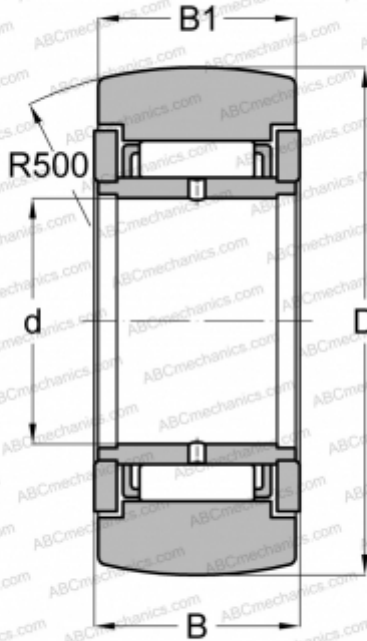

### Technical specification

#### DIMENSIONS, MM

d	17,000
D	40,000
B	20,000
B1	19,800

#### WEIGHT, KG

0,145

#### MANUFACTURER

[SKF](#)

#### INTERCHANGE

ABC	<a href="#">STO 17 ZZ</a>
FAG	<a href="#">STO 17 2Z(NAST 17 2Z)</a>
TORRINGTON	<a href="#">STO 17 ZZ</a>
IKO	<a href="#">NAST 17 ZZR</a>