

STO 20 2Z(NAST 20 2Z) FAG

Yoke type track roller

TYPE: Roller bearings, Yoke type track rollers, Without axial guidance, Outer ring without ribs, shields 2Z, With an inner ring

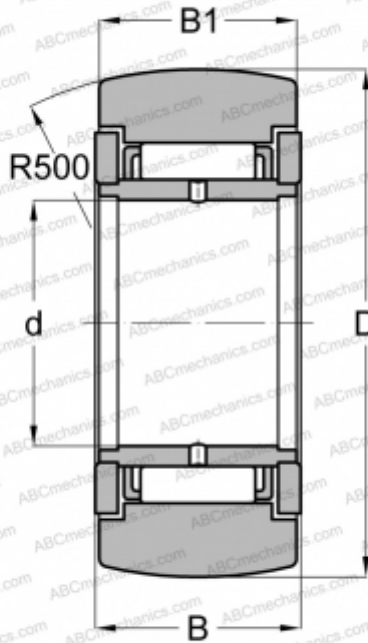

Technical specification

DIMENSIONS, MM

d	20,000
D	47,000
B	20,000
B1	19,800

WEIGHT, KG

0,204

MANUFACTURER

[FAG](#)

INTERCHANGE

ABC	STO 20 ZZ
SKF	NAST 20 2Z
TORRINGTON	STO 20 ZZ
IKO	NAST 20 ZZR