

STO 30 2Z(NAST 30 2Z) FAG

Yoke type track roller

TYPE: Roller bearings, Yoke type track rollers, Without axial guidance, Outer ring without ribs, shields 2Z, With an inner ring

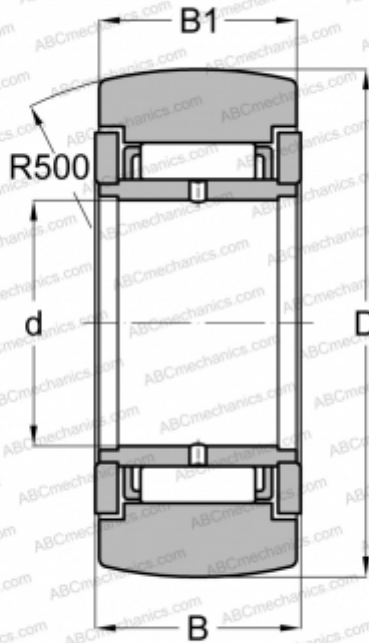

Technical specification

DIMENSIONS, MM

d	30,000
D	62,000
B	25,000
B1	24,800

WEIGHT, KG

0,413

MANUFACTURER

[FAG](#)

INTERCHANGE

ABC	STO 30 ZZ
SKF	NAST 30 2Z
TORRINGTON	STO 30 ZZ
IKO	NAST 30 ZZR