

## NAST 30 2Z SKF

Yoke type track roller

TYPE: Roller bearings, Yoke type track rollers, Without axial guidance, Outer ring without ribs, shields 2Z, With an inner ring

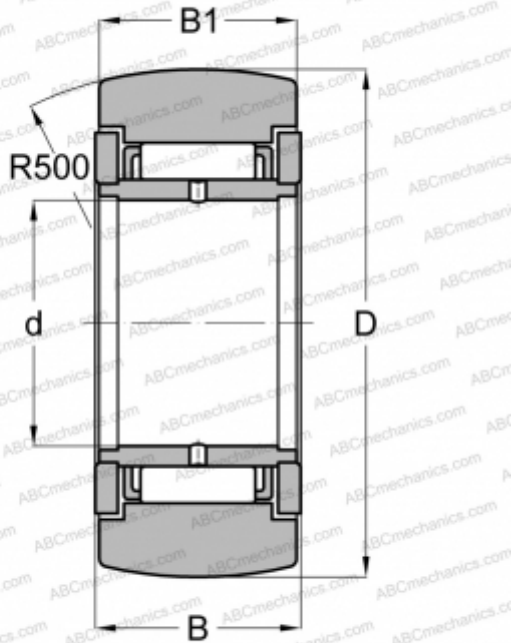

### Technical specification

#### DIMENSIONS, MM

d	30,000
D	62,000
B	25,000
B1	24,800

#### WEIGHT, KG

0,413

#### MANUFACTURER

[SKF](#)

#### INTERCHANGE

ABC	<a href="#">STO 30 ZZ</a>
FAG	<a href="#">STO 30 2Z(NAST 30 2Z)</a>
TORRINGTON	<a href="#">STO 30 ZZ</a>
IKO	<a href="#">NAST 30 ZZR</a>