

STO 45 2Z(NAST 45 2Z) FAG

Yoke type track roller

TYPE: Roller bearings, Yoke type track rollers, Without axial guidance, Outer ring without ribs, shields 2Z, With an inner ring

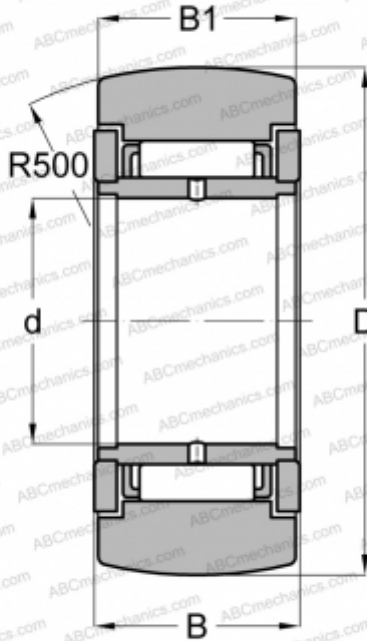

Technical specification

DIMENSIONS, MM

d	45,000
D	85,000
B	26,000
B1	25,800

WEIGHT, KG

0,771

MANUFACTURER

[FAG](#)

INTERCHANGE

ABC	STO 45 ZZ
SKF	NAST 45 2Z
TORRINGTON	STO 45 ZZ
IKO	NAST 45 ZZR