

## NATR 5 DZ/ NATD 5 DZ FAG

Yoke type track roller

TYPE: Roller bearings, Yoke type track rollers, With axial guidance, Gap seals on both side, cylindrical outer ring

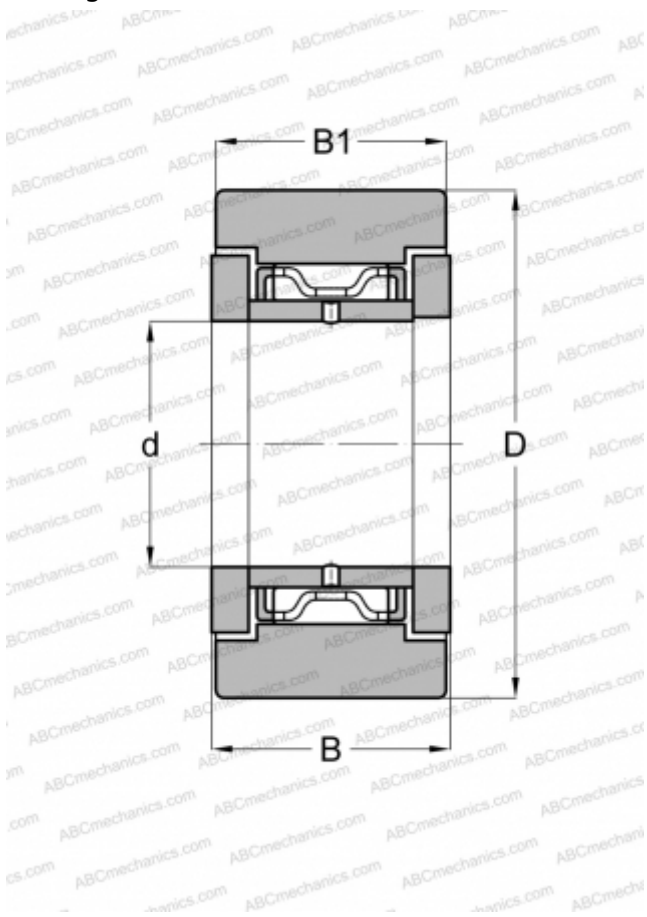

### Technical specification

#### DIMENSIONS, MM

d	5,000
D	16,000
B	12,000
B1	11,000

#### WEIGHT, KG

0,018

#### MANUFACTURER

[FAG](#)

#### INTERCHANGE

ABC	<a href="#">NATR 5 X</a>
INA	<a href="#">NATR 5 X</a>
McGill	<a href="#">MCYRR 5 SX</a>
SKF	<a href="#">NATR 5 X</a>