

NATR 5 X INA

Yoke type track roller

TYPE: Roller bearings, Yoke type track rollers, With axial guidance, Gap seals on both side, cylindrical outer ring

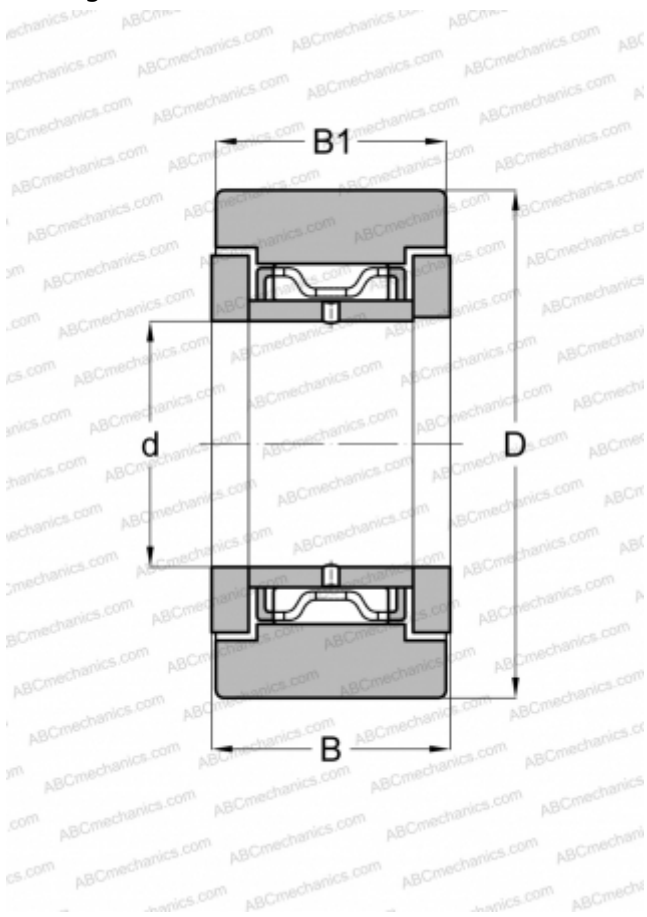

Technical specification

DIMENSIONS, MM

d	5,000
D	16,000
B	12,000
B1	11,000

WEIGHT, KG

0,018

MANUFACTURER

[INA](#)

INTERCHANGE

ABC	NATR 5 X
FAG	NATR 5 DZ/ NATD 5 DZ
McGill	MCYRR 5 SX
SKF	NATR 5 X