

MCYRR 6 SX McGill

Yoke type track roller

TYPE: Roller bearings, Yoke type track rollers, With axial guidance, Gap seals on both side, cylindrical outer ring

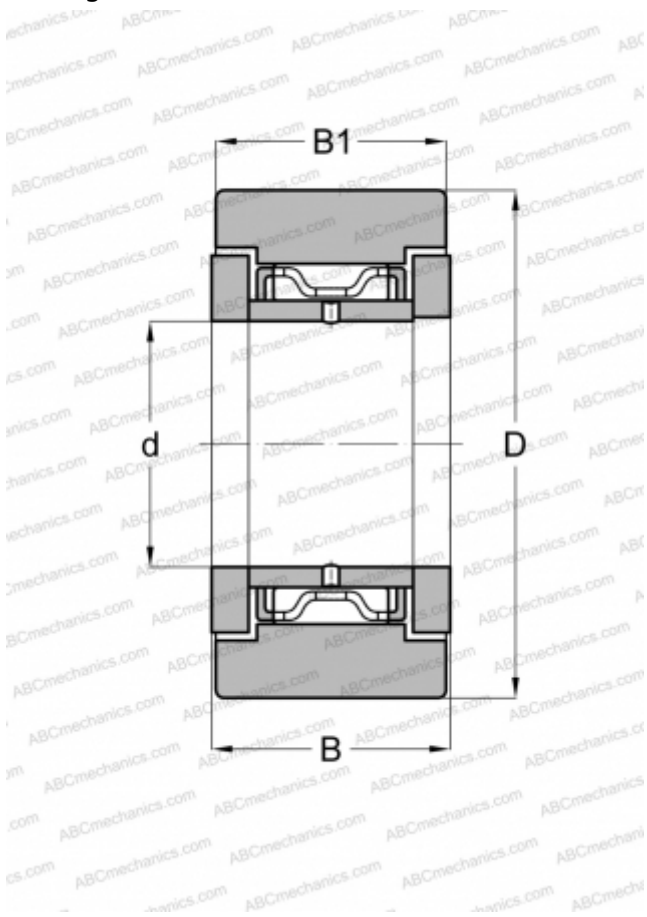

Technical specification

DIMENSIONS, MM

d	6,000
D	19,000
B	12,000
B1	11,000

WEIGHT, KG

0,023

MANUFACTURER

[McGill](#)

INTERCHANGE

ABC	NATR 6 X
FAG	NATR 6 DZ/ NATD 6 DZ
INA	NATR 6 X
SKF	NATR 6 X