

## NATR 8 DZ/ NATD 8 DZ FAG

Yoke type track roller

TYPE: Roller bearings, Yoke type track rollers, With axial guidance, Gap seals on both side, cylindrical outer ring

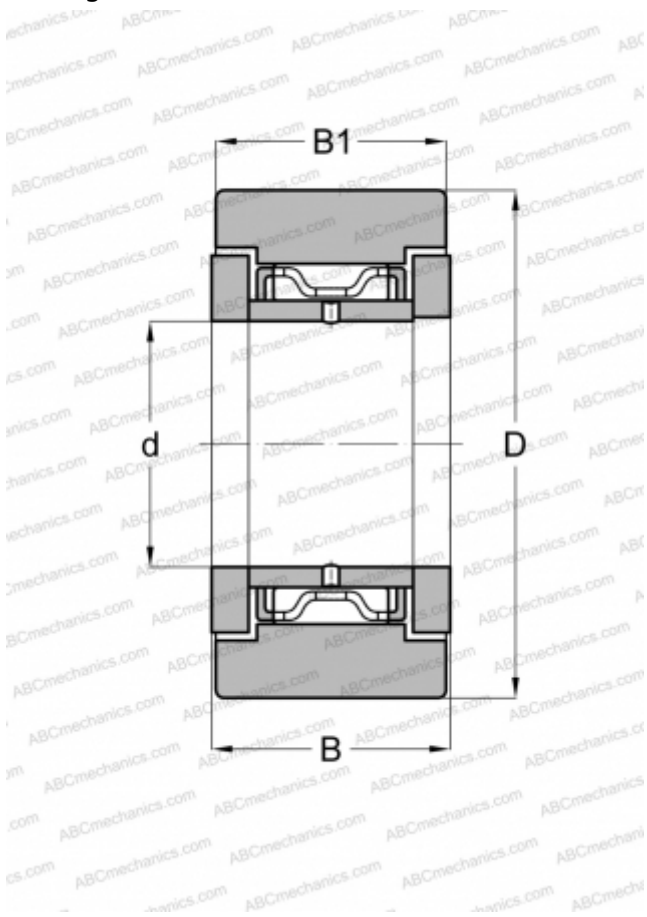

### Technical specification

#### DIMENSIONS, MM

d	8,000
D	24,000
B	15,000
B1	14,000

#### WEIGHT, KG

0,045

#### MANUFACTURER

[FAG](#)

#### INTERCHANGE

ABC	<a href="#">NATR 8 X</a>
INA	<a href="#">NATR 8 X</a>
McGill	<a href="#">MCYRR 8 SX</a>
SKF	<a href="#">NATR 8 X</a>