

NATR 8 X INA

Yoke type track roller

TYPE: Roller bearings, Yoke type track rollers, With axial guidance, Gap seals on both side, cylindrical outer ring

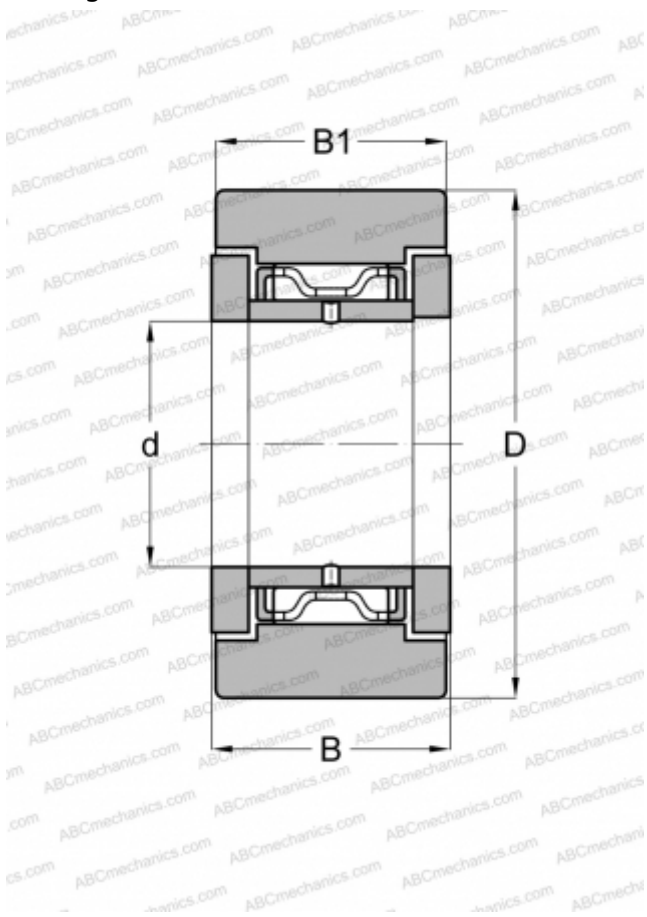

Technical specification

DIMENSIONS, MM

d	8,000
D	24,000
B	15,000
B1	14,000

WEIGHT, KG

0,045

MANUFACTURER

[INA](#)

INTERCHANGE

ABC	NATR 8 X
FAG	NATR 8 DZ/ NATD 8 DZ
McGill	MCYRR 8 SX
SKF	NATR 8 X