

NATR 8 X SKF

Yoke type track roller

TYPE: Roller bearings, Yoke type track rollers, With axial guidance, Gap seals on both side, cylindrical outer ring

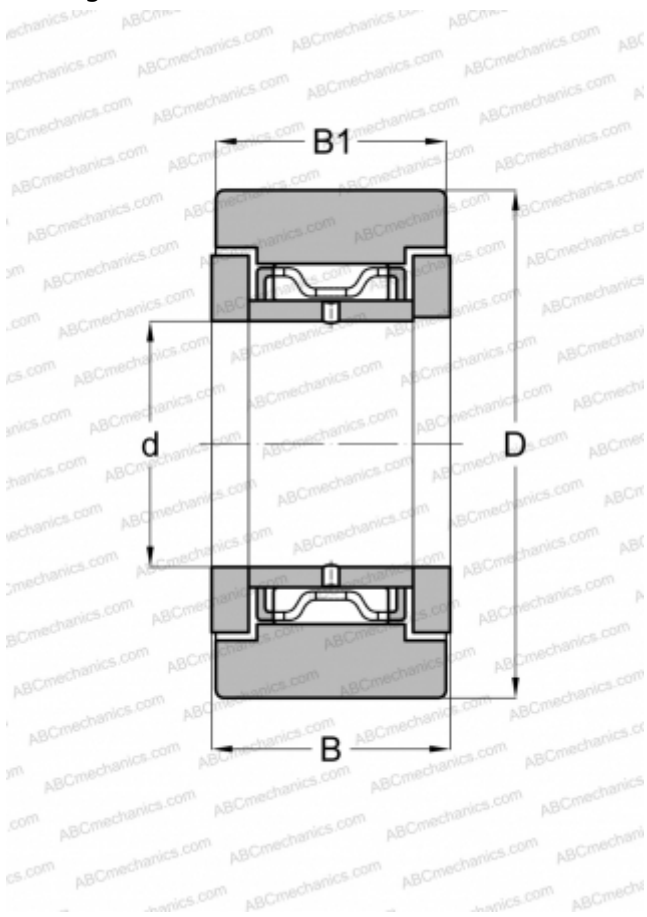

Technical specification

DIMENSIONS, MM

d	8,000
D	24,000
B	15,000
B1	14,000

WEIGHT, KG

0,041

MANUFACTURER

[SKF](#)

INTERCHANGE

ABC	NATR 8 X
FAG	NATR 8 DZ/ NATD 8 DZ
INA	NATR 8 X
McGill	MCYRR 8 SX

CALCULATION DATA

Basic dynamic load rating, C	5,280 kN
Basic static load rating, Co	6,100 kN
Fatigue load limit, Pu	0,695 kN
Limiting speed	5000 r/min