

NATR 10 X ABC

Yoke type track roller

TYPE: Roller bearings, Yoke type track rollers, With axial guidance, Gap seals on both side, cylindrical outer ring

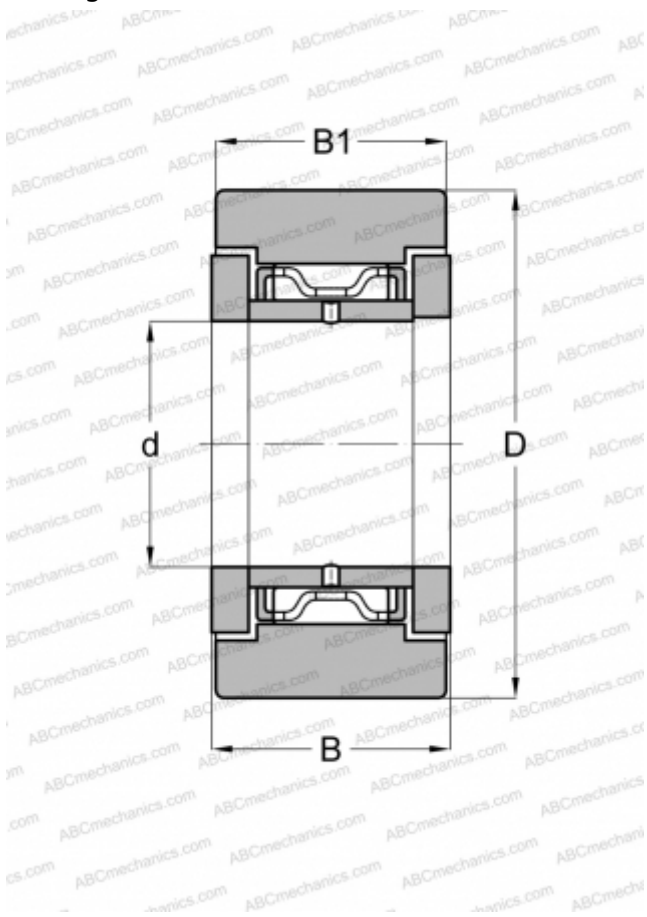

Technical specification

DIMENSIONS, MM

d	10,000
D	30,000
B	15,000
B1	14,000

WEIGHT, KG

0,068

MANUFACTURER

[ABC](#)

INTERCHANGE

FAG	NATR 10 DZ/ NATD 10 DZ
INA	NATR 10 X
McGill	MCYRR 10 SX
SKF	NATR 10 X