

NATR 12 X INA

Yoke type track roller

TYPE: Roller bearings, Yoke type track rollers, With axial guidance, Gap seals on both side, cylindrical outer ring

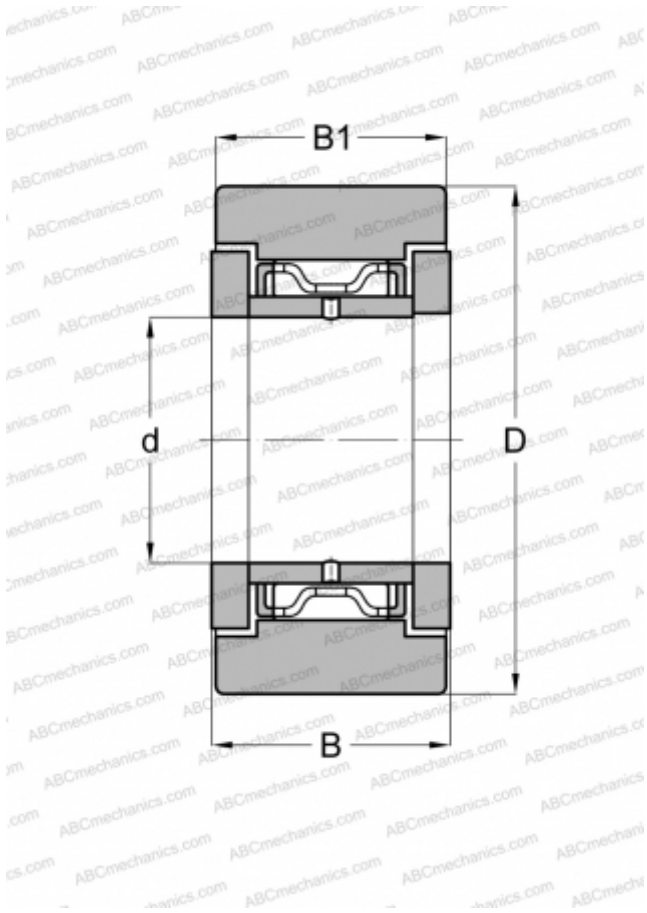

Technical specification

DIMENSIONS, MM

d	12,000
D	32,000
B	15,000
B1	14,000

WEIGHT, KG

0,077

MANUFACTURER

[INA](#)

INTERCHANGE

ABC	NATR 12 X
FAG	NATR 12 DZ/ NATD 12 DZ
McGill	MCYRR 12 SX
SKF	NATR 12 X