

## MCYRR 12 SX McGill

Yoke type track roller

TYPE: Roller bearings, Yoke type track rollers, With axial guidance, Gap seals on both side, cylindrical outer ring

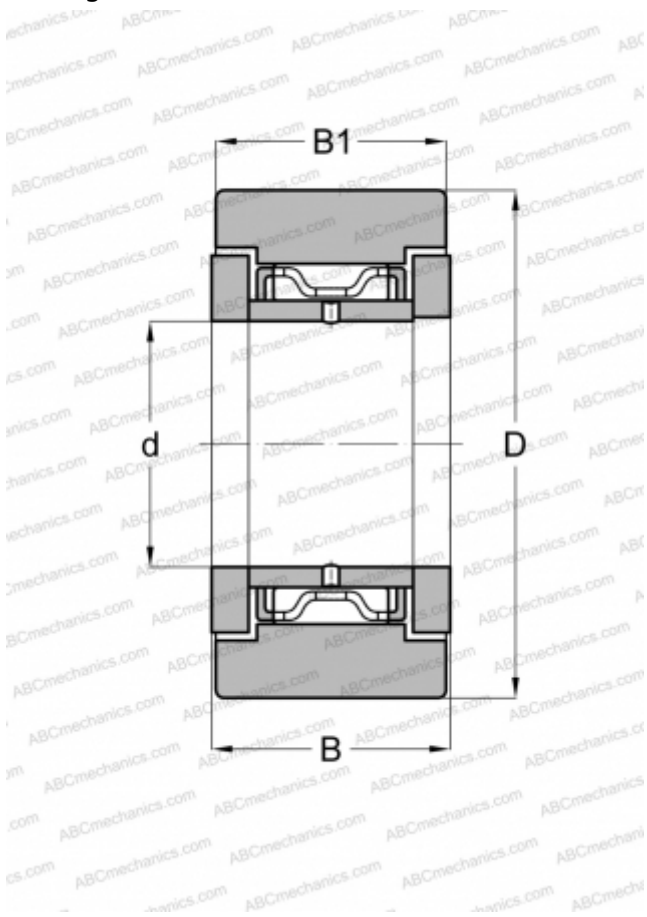

### Technical specification

#### DIMENSIONS, MM

d	12,000
D	32,000
B	15,000
B1	14,000

#### WEIGHT, KG

0,077

#### MANUFACTURER

[McGill](#)

#### INTERCHANGE

ABC	<a href="#">NATR 12 X</a>
FAG	<a href="#">NATR 12 DZ/ NATD 12 DZ</a>
INA	<a href="#">NATR 12 X</a>
SKF	<a href="#">NATR 12 X</a>