

NATR 15 X SKF

Yoke type track roller

TYPE: Roller bearings, Yoke type track rollers, With axial guidance, Gap seals on both side, cylindrical outer ring

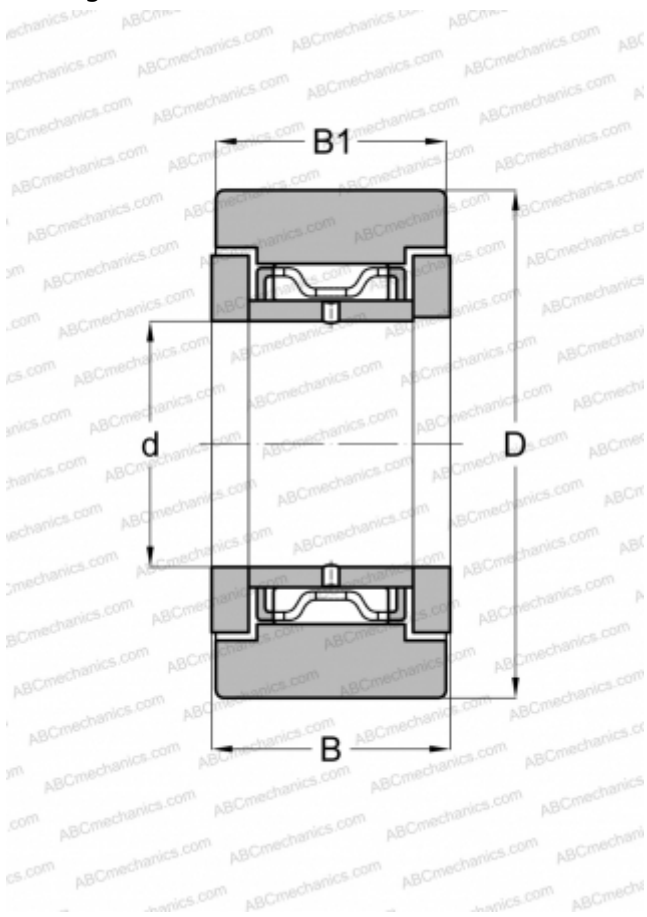

Technical specification

DIMENSIONS, MM

d	15,000
D	35,000
B	19,000
B1	18,000

WEIGHT, KG

0,100

MANUFACTURER

[SKF](#)

INTERCHANGE

ABC	NATR 15 X
INA	NATR 15 X

CALCULATION DATA

Basic dynamic load rating, C	9,520 kN
Basic static load rating, Co	13,700 kN
Fatigue load limit, Pu	1,560 kN
Limiting speed	4000 r/min