

NATR 17 X INA

Yoke type track roller

TYPE: Roller bearings, Yoke type track rollers, With axial guidance, Gap seals on both side, cylindrical outer ring

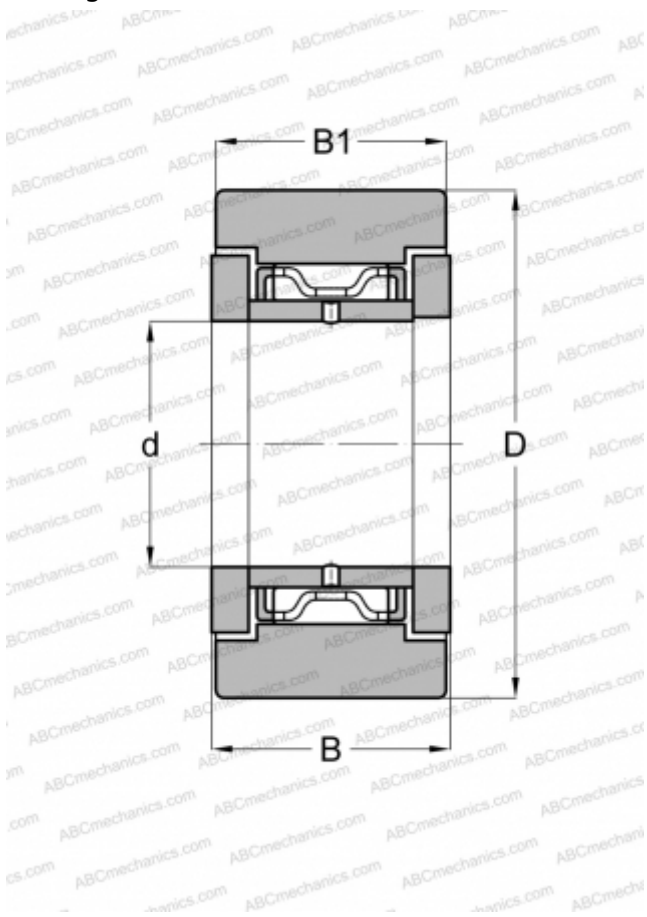

Technical specification

DIMENSIONS, MM

d	17,000
D	40,000
B	21,000
B1	20,000

WEIGHT, KG

0,139

MANUFACTURER

[INA](#)

INTERCHANGE

ABC	NATR 17 X
SKF	NATR 17 X