

NATR 20 X ABC

Yoke type track roller

TYPE: Roller bearings, Yoke type track rollers, With axial guidance, Gap seals on both side, cylindrical outer ring

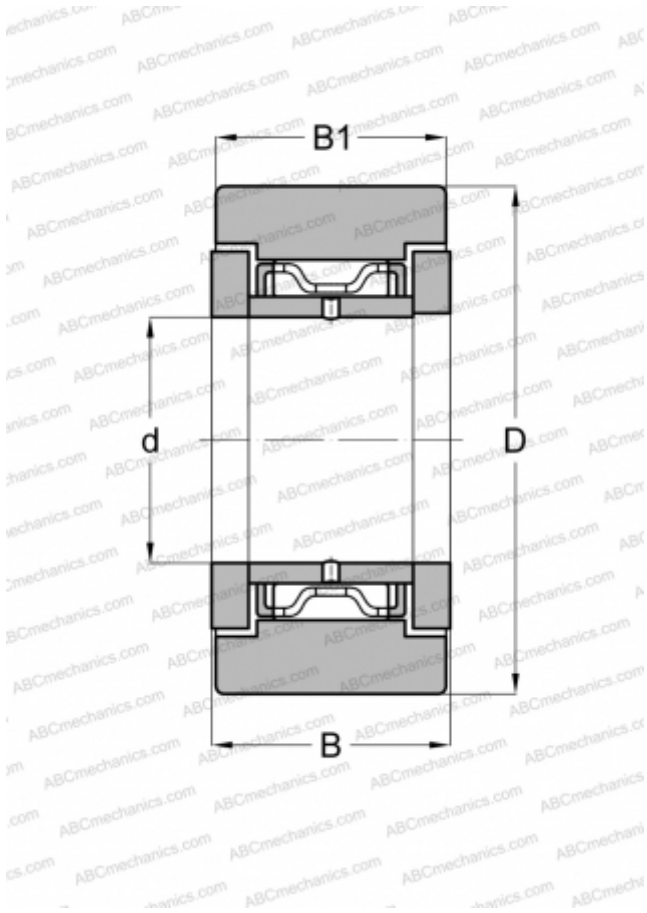

Technical specification

DIMENSIONS, MM

d	20,000
D	47,000
B	25,000
B1	24,000

WEIGHT, KG

0,236

MANUFACTURER

[ABC](#)

INTERCHANGE

INA	NATR 20 X
SKF	NATR 20 X