

NATR 25 X SKF

Yoke type track roller

TYPE: Roller bearings, Yoke type track rollers, With axial guidance, Gap seals on both side, cylindrical outer ring

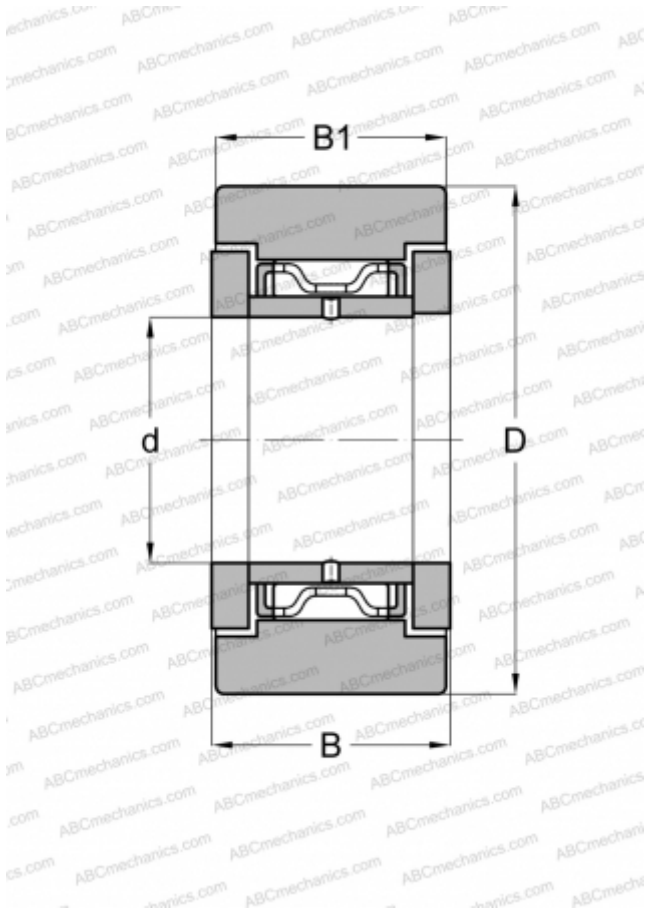

Technical specification

DIMENSIONS, MM

d	25,000
D	52,000
B	25,000
B1	24,000

WEIGHT, KG

0,280

MANUFACTURER

[SKF](#)

INTERCHANGE

ABC	NATR 25 X
INA	NATR 25 X

CALCULATION DATA

Basic dynamic load rating, C	14,700 kN
Basic static load rating, Co	25,500 kN
Fatigue load limit, Pu	3,100 kN
Limiting speed	2400 r/min