

NATR 30 X ABC

Yoke type track roller

TYPE: Roller bearings, Yoke type track rollers, With axial guidance, Gap seals on both side, cylindrical outer ring

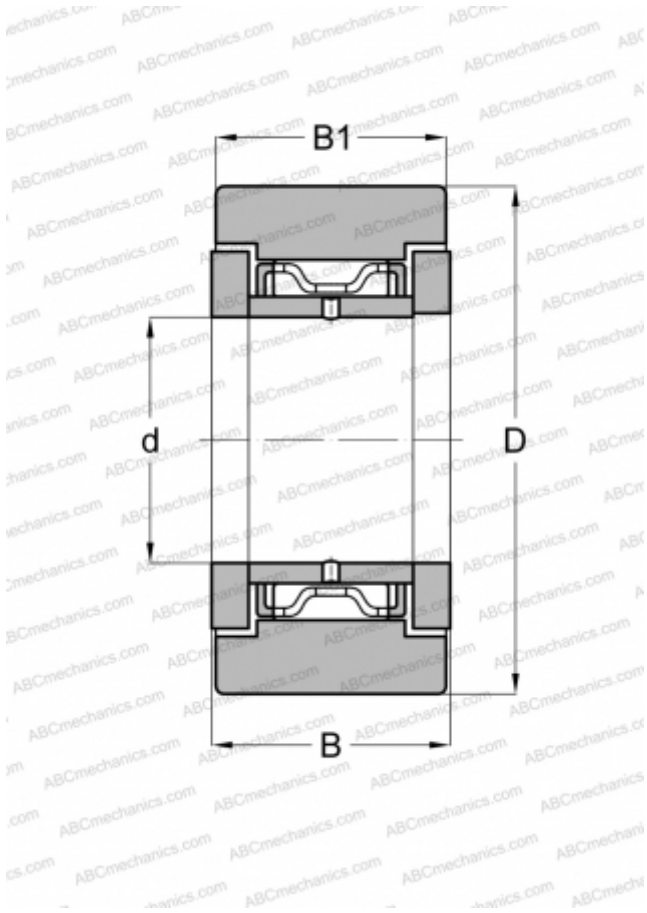

Technical specification

DIMENSIONS, MM

d	30,000
D	62,000
B	29,000
B1	28,000

WEIGHT, KG

0,444

MANUFACTURER

[ABC](#)

INTERCHANGE

INA	NATR 30 X
SKF	NATR 30 X