

## NATR 30 X INA

Yoke type track roller

TYPE: Roller bearings, Yoke type track rollers, With axial guidance, Gap seals on both side, cylindrical outer ring

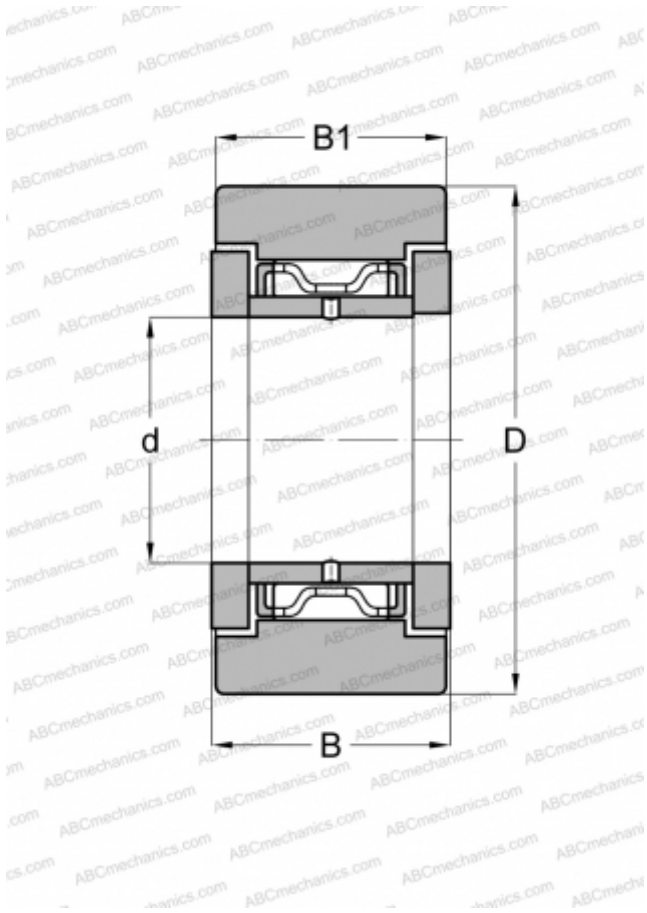

### Technical specification

#### DIMENSIONS, MM

d	30,000
D	62,000
B	29,000
B1	28,000

#### WEIGHT, KG

0,444

#### MANUFACTURER

[INA](#)

#### INTERCHANGE

ABC	<a href="#">NATR 30 X</a>
SKF	<a href="#">NATR 30 X</a>