

NATR 30 X SKF

Yoke type track roller

TYPE: Roller bearings, Yoke type track rollers, With axial guidance, Gap seals on both side, cylindrical outer ring

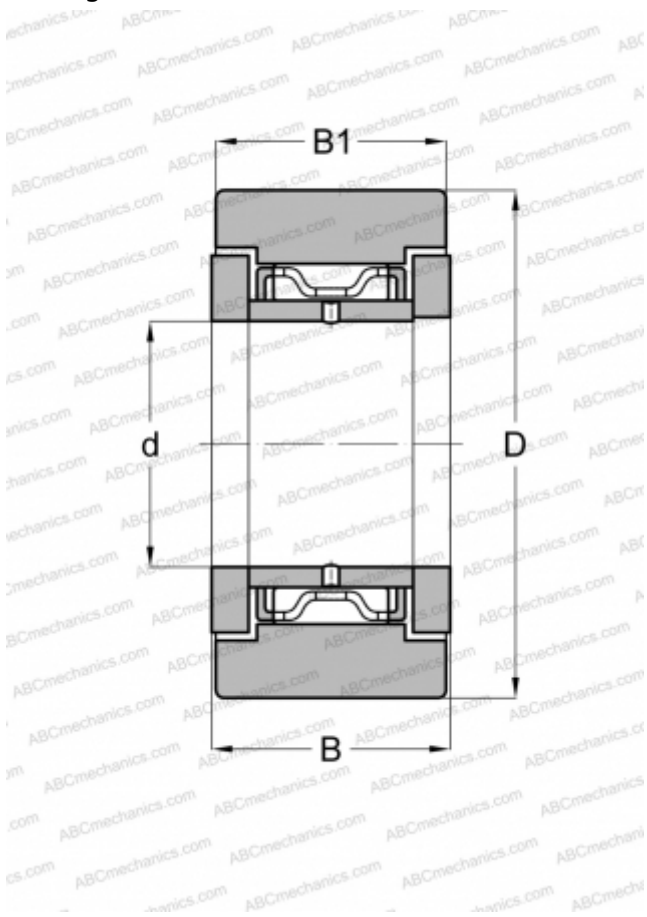

Technical specification

DIMENSIONS, MM

d	30,000
D	62,000
B	29,000
B1	28,000

WEIGHT, KG

0,470

MANUFACTURER

[SKF](#)

INTERCHANGE

ABC	NATR 30 X
INA	NATR 30 X

CALCULATION DATA

Basic dynamic load rating, C	22,900 kN
Basic static load rating, Co	37,500 kN
Fatigue load limit, Pu	4,550 kN
Limiting speed	1800 r/min