

NATR 6 PPX SKF

Yoke type track roller

TYPE: Roller bearings, Yoke type track rollers, With axial guidance, Sealing rings on both sides, cylindrical outer ring

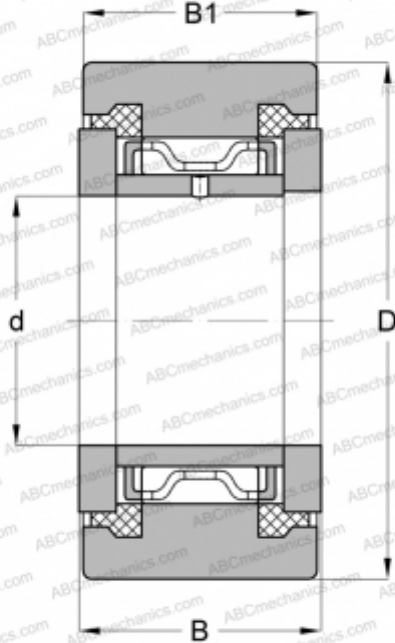

Technical specification

DIMENSIONS, MM

d	6,000
D	19,000
B	12,000
B1	11,000

WEIGHT, KG

0,019

MANUFACTURER

[SKF](#)

INTERCHANGE

ABC	NATR 6 PPX
INA	NATR 6 PPX
McGill	MCYRR 6 SX

CALCULATION DATA

Basic dynamic load rating, C	3,470 kN
Basic static load rating, Co	3,800 kN
Fatigue load limit, Pu	0,415 kN
Limiting speed	5600 r/min