

## NATR 17 PPX SKF

Yoke type track roller

TYPE: Roller bearings, Yoke type track rollers, With axial guidance, Sealing rings on both sides, cylindrical outer ring

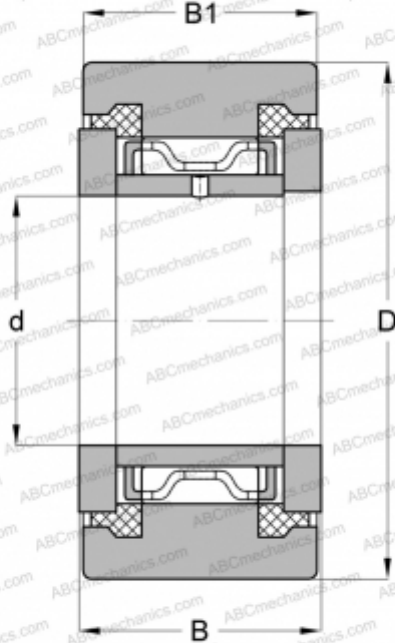

### Technical specification

#### DIMENSIONS, MM

d	17,000
D	40,000
B	21,000
B1	20,000

#### WEIGHT, KG

0,140

#### MANUFACTURER

[SKF](#)

#### INTERCHANGE

ABC	<a href="#">NATR 17 PPX</a>
INA	<a href="#">NATR 17 PPX</a>

#### CALCULATION DATA

Basic dynamic load rating, C	10,500 kN
Basic static load rating, Co	14,600 kN
Fatigue load limit, Pu	1,730 kN
Limiting speed	3400 r/min