

## NATR 25 PPX SKF

Yoke type track roller

TYPE: Roller bearings, Yoke type track rollers, With axial guidance, Sealing rings on both sides, cylindrical outer ring

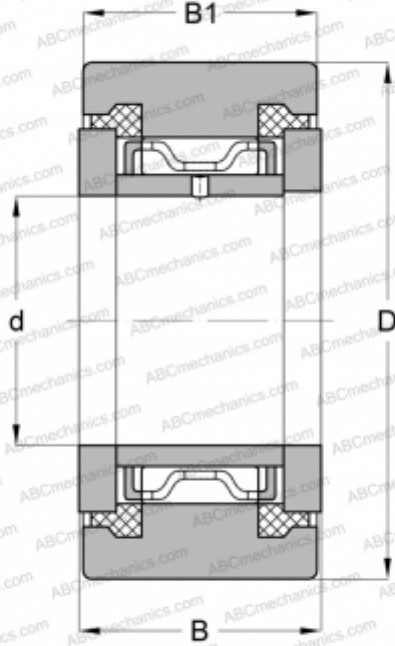

### Technical specification

#### DIMENSIONS, MM

d	25,000
D	52,000
B	25,000
B1	24,000

#### WEIGHT, KG

0,270

#### MANUFACTURER

[SKF](#)

#### INTERCHANGE

ABC	<a href="#">NATR 25 PPX</a>
INA	<a href="#">NATR 25 PPX</a>

#### CALCULATION DATA

Basic dynamic load rating, C	14,700 kN
Basic static load rating, Co	25,500 kN
Fatigue load limit, Pu	3,100 kN
Limiting speed	2400 r/min