

NATR 40 PPX ABC

Yoke type track roller

TYPE: Roller bearings, Yoke type track rollers, With axial guidance, Sealing rings on both sides, cylindrical outer ring

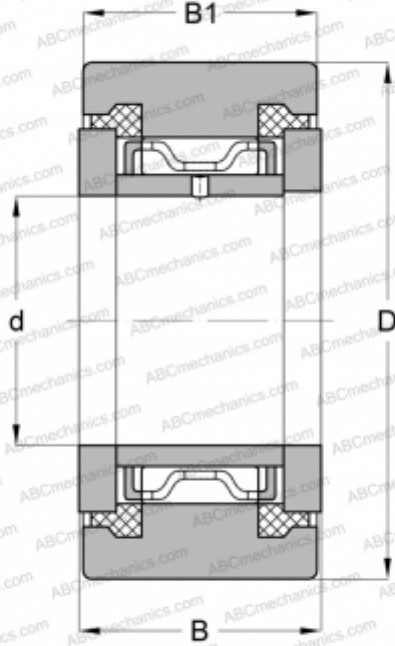

Technical specification

DIMENSIONS, MM

d	40,000
D	80,000
B	32,000
B1	30,000

WEIGHT, KG

0,800

MANUFACTURER

[ABC](#)

INTERCHANGE

SKF

[NATR 40 PPX](#)