

NATR 50 PPX SKF

Yoke type track roller

TYPE: Roller bearings, Yoke type track rollers, With axial guidance, Sealing rings on both sides, cylindrical outer ring

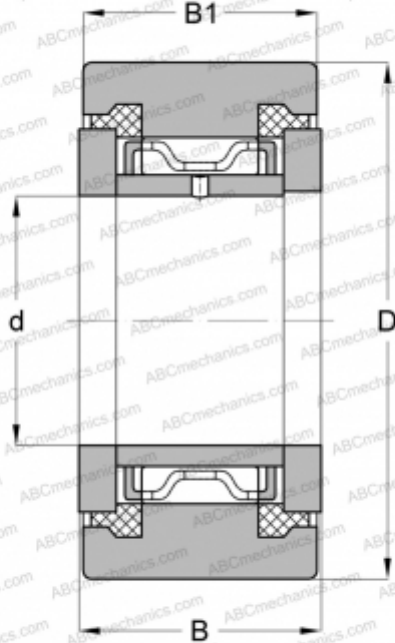

Technical specification

DIMENSIONS, MM

d	50,000
D	90,000
B	32,000
B1	30,000

WEIGHT, KG

0,870

MANUFACTURER

[SKF](#)

INTERCHANGE

ABC	NATR 50 PPX
-----	-----------------------------

CALCULATION DATA

Basic dynamic load rating, C	30,800 kN
Basic static load rating, Co	58,500 kN
Fatigue load limit, Pu	7,200 kN
Limiting speed	1200 r/min