

NNTR 50x130x65.2ZL SKF

Yoke type track roller

TYPE: Roller bearings, Yoke type track rollers, With axial guidance, Full complement roller set, central rib, sealing shields with lamellar ring on both sides

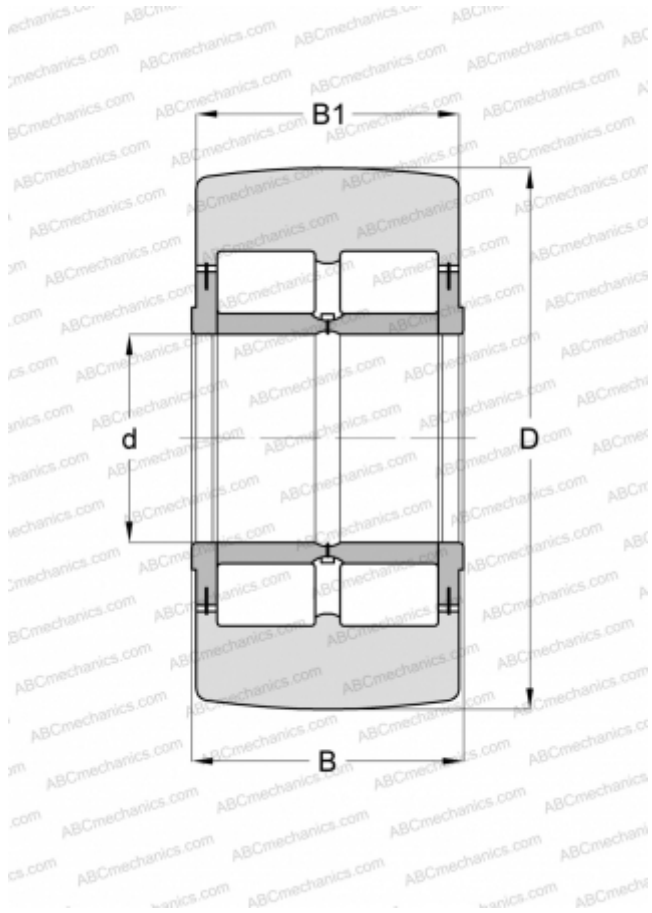

Technical specification

DIMENSIONS, MM

d	50,000
D	130,000
B	65,000
B1	63,000

WEIGHT, KG

5,200

MANUFACTURER

[SKF](#)

INTERCHANGE

ABC	NNTR 50X130X65 2ZL
INA	NNTR 50X130X65 2ZL

CALCULATION DATA

Basic dynamic load rating, C	179,000 kN
Basic static load rating, Co	232,000 kN
Fatigue load limit, Pu	31,000 kN
Limiting speed	750 r/min