

NNTR 55x140x70.2ZL SKF

Yoke type track roller

TYPE: Roller bearings, Yoke type track rollers, With axial guidance, Full complement roller set, central rib, sealing shields with lamellar ring on both sides

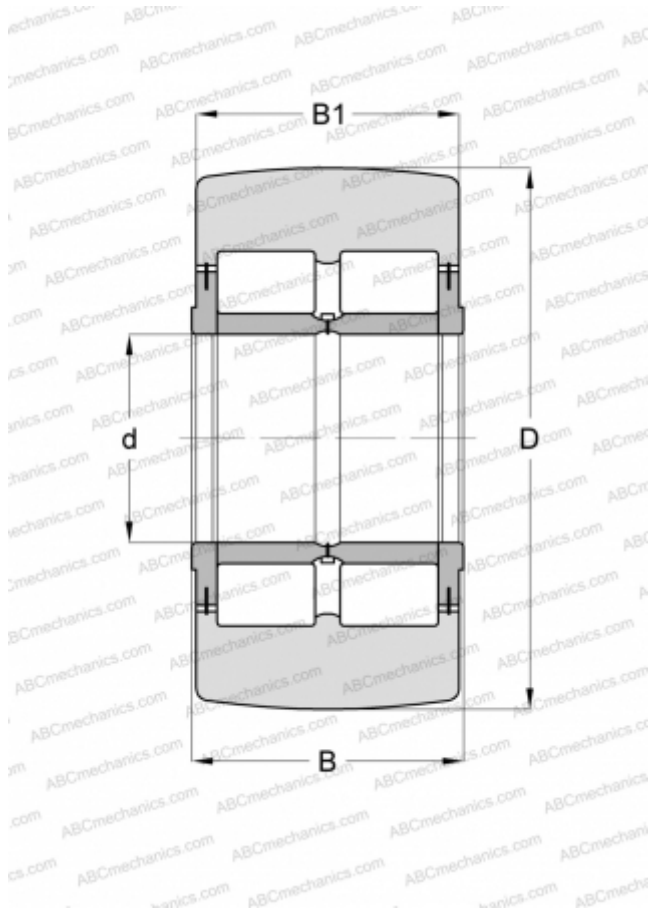

Technical specification

DIMENSIONS, MM

d	55,000
D	140,000
B	70,000
B1	68,000

WEIGHT, KG

6,400

MANUFACTURER

[SKF](#)

INTERCHANGE

ABC	NNTR 55X140X70 2ZL
INA	NNTR 55X140X70 2ZL

CALCULATION DATA

Basic dynamic load rating, C	209,000 kN
Basic static load rating, Co	275,000 kN
Fatigue load limit, Pu	37,500 kN
Limiting speed	700 r/min