

NNTR 60x150x75.2ZL SKF

Yoke type track roller

TYPE: Roller bearings, Yoke type track rollers, With axial guidance, Full complement roller set, central rib, sealing shields with lamellar ring on both sides

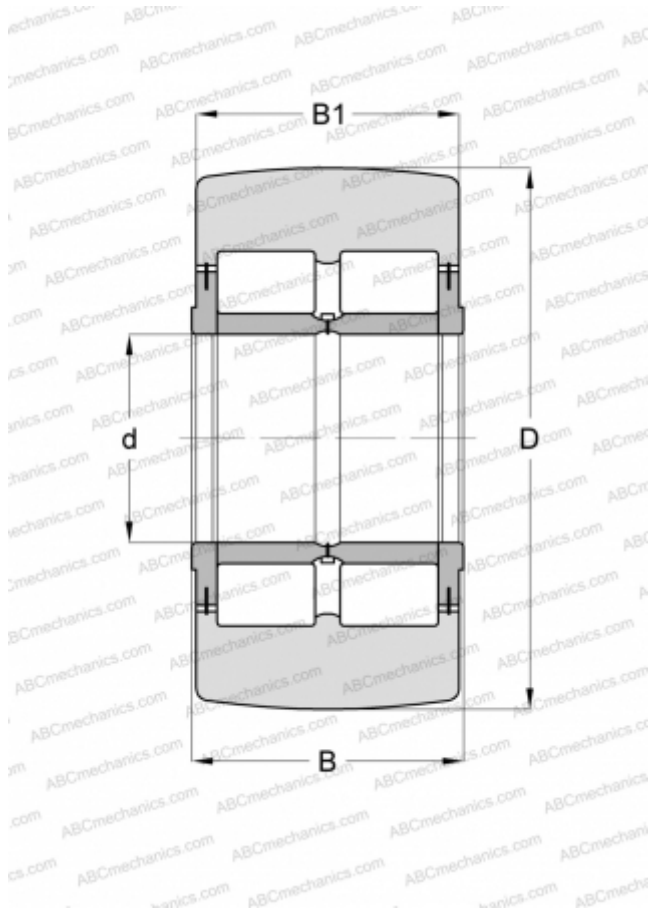

Technical specification

DIMENSIONS, MM

d	60,000
D	150,000
B	75,000
B1	73,000

WEIGHT, KG

7,800

MANUFACTURER

[SKF](#)

INTERCHANGE

ABC	NNTR 60X150X75 2ZL
INA	NNTR 60X150X75 2ZL

CALCULATION DATA

Basic dynamic load rating, C	238,000 kN
Basic static load rating, Co	320,000 kN
Fatigue load limit, Pu	42,500 kN
Limiting speed	670 r/min