

NNTR 65x160x75.2ZL SKF

Yoke type track roller

TYPE: Roller bearings, Yoke type track rollers, With axial guidance, Full complement roller set, central rib, sealing shields with lamellar ring on both sides

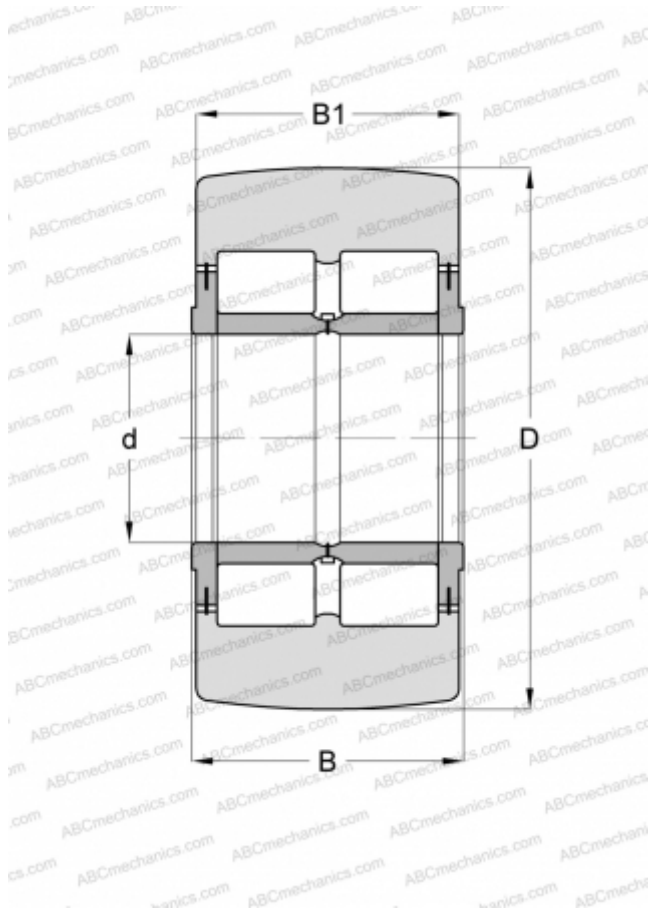

Technical specification

DIMENSIONS, MM

d	65,000
D	160,000
B	75,000
B1	73,000

WEIGHT, KG

8,800

MANUFACTURER

[SKF](#)

INTERCHANGE

ABC	NNTR 65X160X75 2ZL
INA	NNTR 65X160X75 2ZL

CALCULATION DATA

Basic dynamic load rating, C	255,000 kN
Basic static load rating, Co	345,000 kN
Fatigue load limit, Pu	46,500 kN
Limiting speed	600 r/min