

NNTR 80x200x90.2ZL SKF

Yoke type track roller

TYPE: Roller bearings, Yoke type track rollers, With axial guidance, Full complement roller set, central rib, sealing shields with lamellar ring on both sides

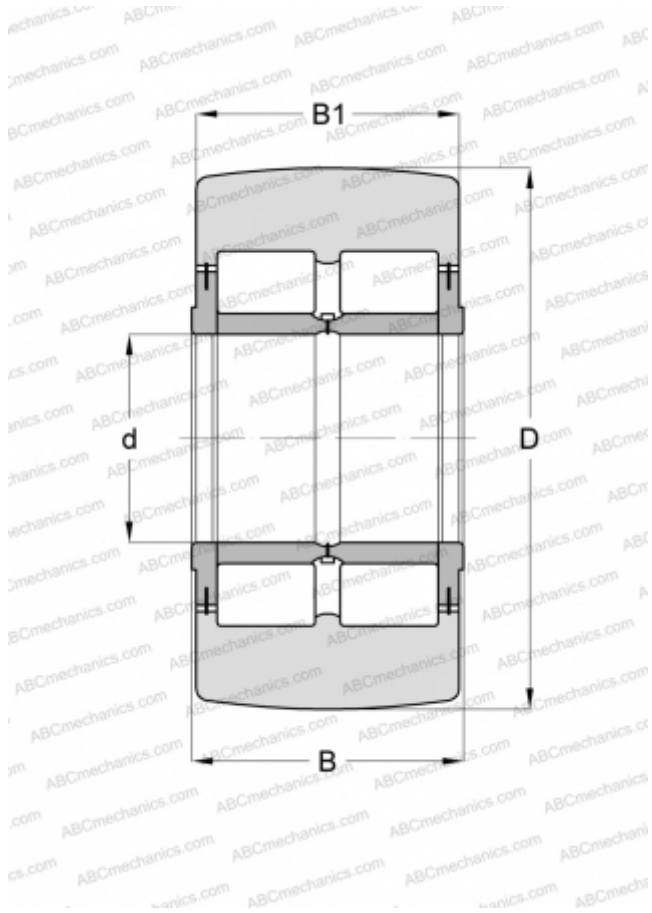

Technical specification

DIMENSIONS, MM

d	80,000
D	200,000
B	90,000
B1	88,000

WEIGHT, KG

17,000

MANUFACTURER

[SKF](#)

INTERCHANGE

ABC	NNTR 80X200X90 2ZL
INA	NNTR 80X200X90 2ZL

CALCULATION DATA

Basic dynamic load rating, C	391,000 kN
Basic static load rating, Co	540,000 kN
Fatigue load limit, Pu	71,000 kN
Limiting speed	500 r/min