

NNTR 90x220x100.2ZL SKF

Yoke type track roller

TYPE: Roller bearings, Yoke type track rollers, With axial guidance, Full complement roller set, central rib, sealing shields with lamellar ring on both sides

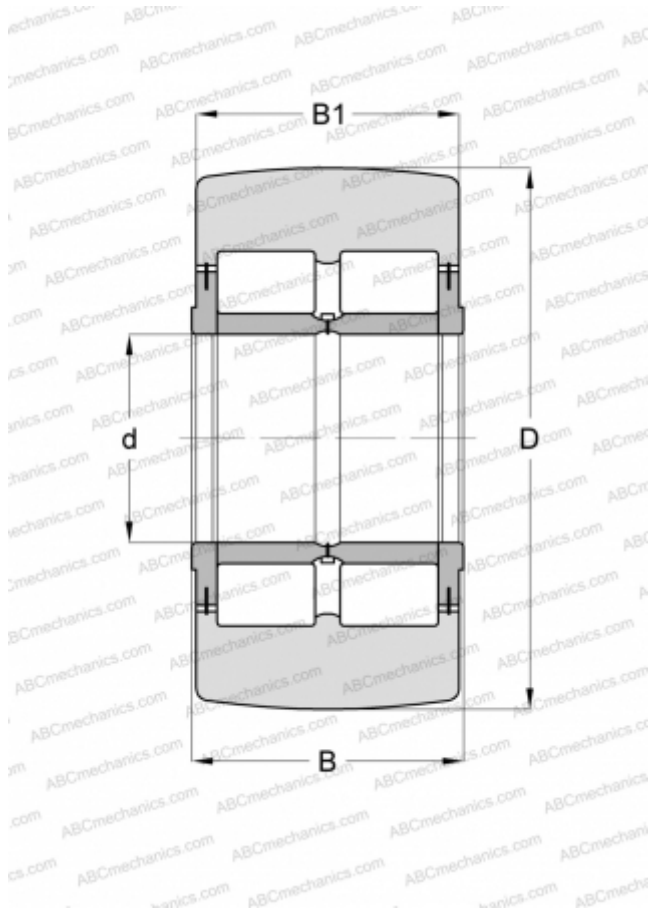

Technical specification

DIMENSIONS, MM

d	90,000
D	220,000
B	100,000
B1	98,000

WEIGHT, KG

22,500

MANUFACTURER

[SKF](#)

INTERCHANGE

ABC	NNTR 90X220X100 2ZL
INA	NNTR 90X220X100 2ZL

CALCULATION DATA

Basic dynamic load rating, C	468,000 kN
Basic static load rating, Co	670,000 kN
Fatigue load limit, Pu	83,000 kN
Limiting speed	430 r/min