

NNTR 100x240x105.2ZL SKF

Yoke type track roller

TYPE: Roller bearings, Yoke type track rollers, With axial guidance, Full complement roller set, central rib, sealing shields with lamellar ring on both sides

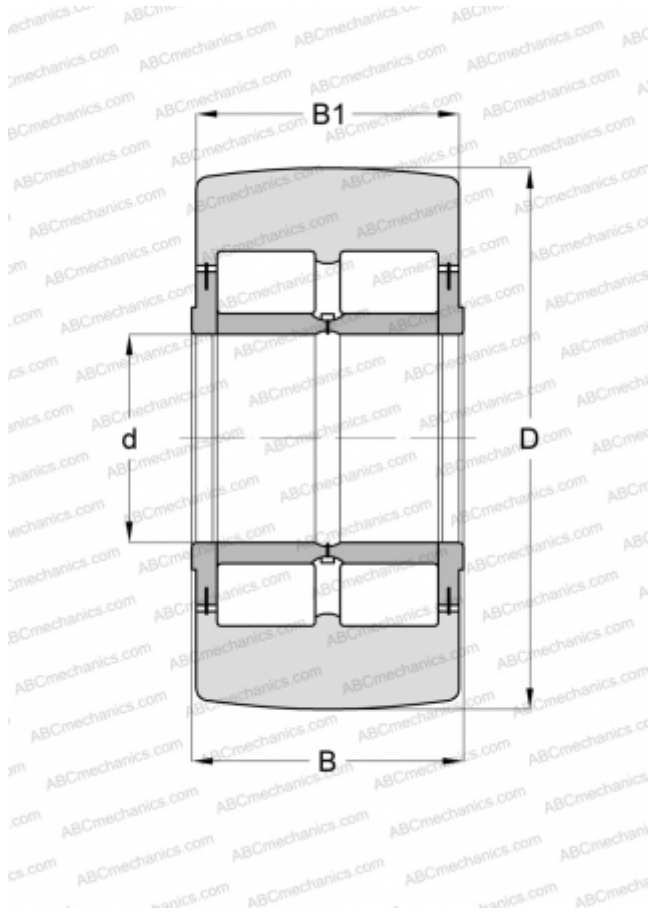

Technical specification

DIMENSIONS, MM

d	100,000
D	240,000
B	105,000
B1	103,000

WEIGHT, KG

28,000

MANUFACTURER

[SKF](#)

INTERCHANGE

ABC	NNTR 100X240X105 2ZL
INA	NNTR 100X240X105 2ZL

CALCULATION DATA

Basic dynamic load rating, C	528,000 kN
Basic static load rating, Co	780,000 kN
Fatigue load limit, Pu	93,000 kN
Limiting speed	380 r/min