

NNTR 110x260x115.2ZL SKF

Yoke type track roller

TYPE: Roller bearings, Yoke type track rollers, With axial guidance, Full complement roller set, central rib, sealing shields with lamellar ring on both sides

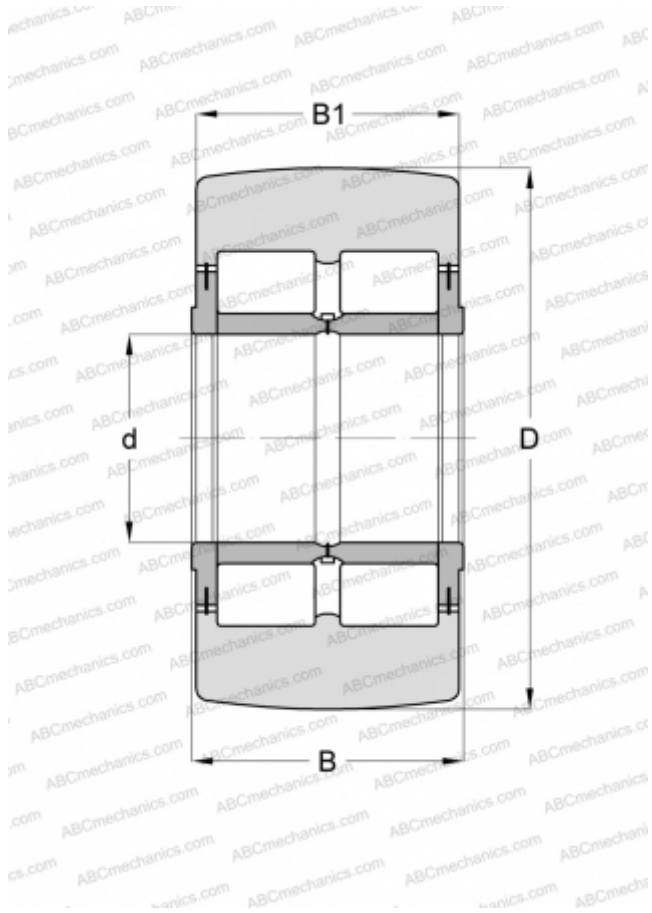

Technical specification

DIMENSIONS, MM

d	110,000
D	260,000
B	115,000
B1	113,000

WEIGHT, KG

35,500

MANUFACTURER

[SKF](#)

INTERCHANGE

ABC	NNTR 110X260X115 2ZL
INA	NNTR 110X260X115 2ZL

CALCULATION DATA

Basic dynamic load rating, C	627,000 kN
Basic static load rating, Co	930,000 kN
Fatigue load limit, Pu	112,000 kN
Limiting speed	360 r/min