

NNTR 120x290x135.2ZL SKF

Yoke type track roller

TYPE: Roller bearings, Yoke type track rollers, With axial guidance, Full complement roller set, central rib, sealing shields with lamellar ring on both sides

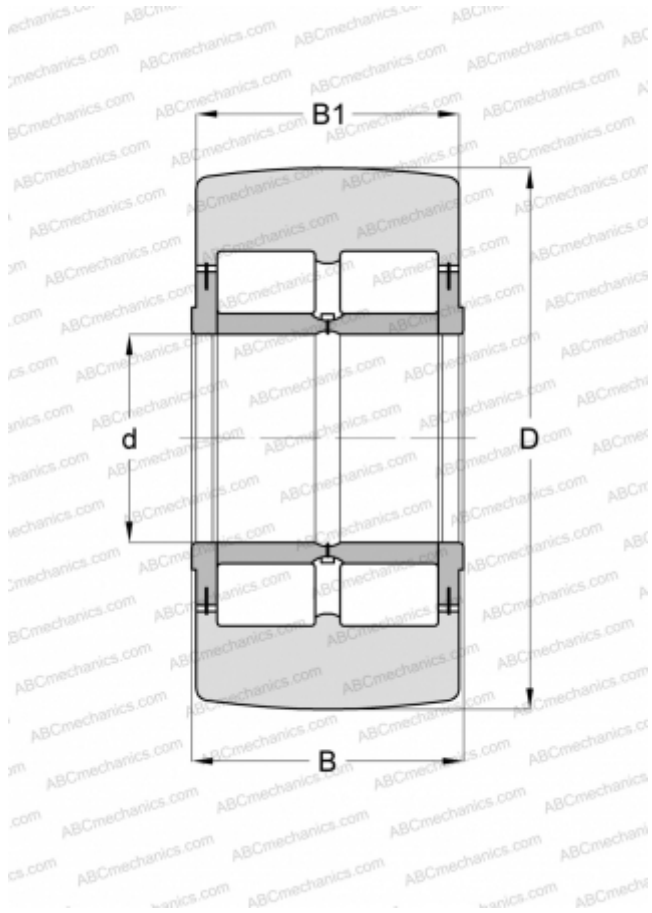

Technical specification

DIMENSIONS, MM

d	120,000
D	290,000
B	135,000
B1	133,000

WEIGHT, KG

53,000

MANUFACTURER

[SKF](#)

INTERCHANGE

ABC	NNTR 120X290X135 2ZL
INA	NNTR 120X290X135 2ZL

CALCULATION DATA

Basic dynamic load rating, C	825,000 kN
Basic static load rating, Co	1270,000 kN
Fatigue load limit, Pu	143,000 kN
Limiting speed	320 r/min