

MCFD 40 SX McGill

Cam followers

TYPE: Roller bearings, Stud type track rollers, With axial guidance, full complement cylindrical roller set, labyrinth seals on both sides, cylindrical outer ring

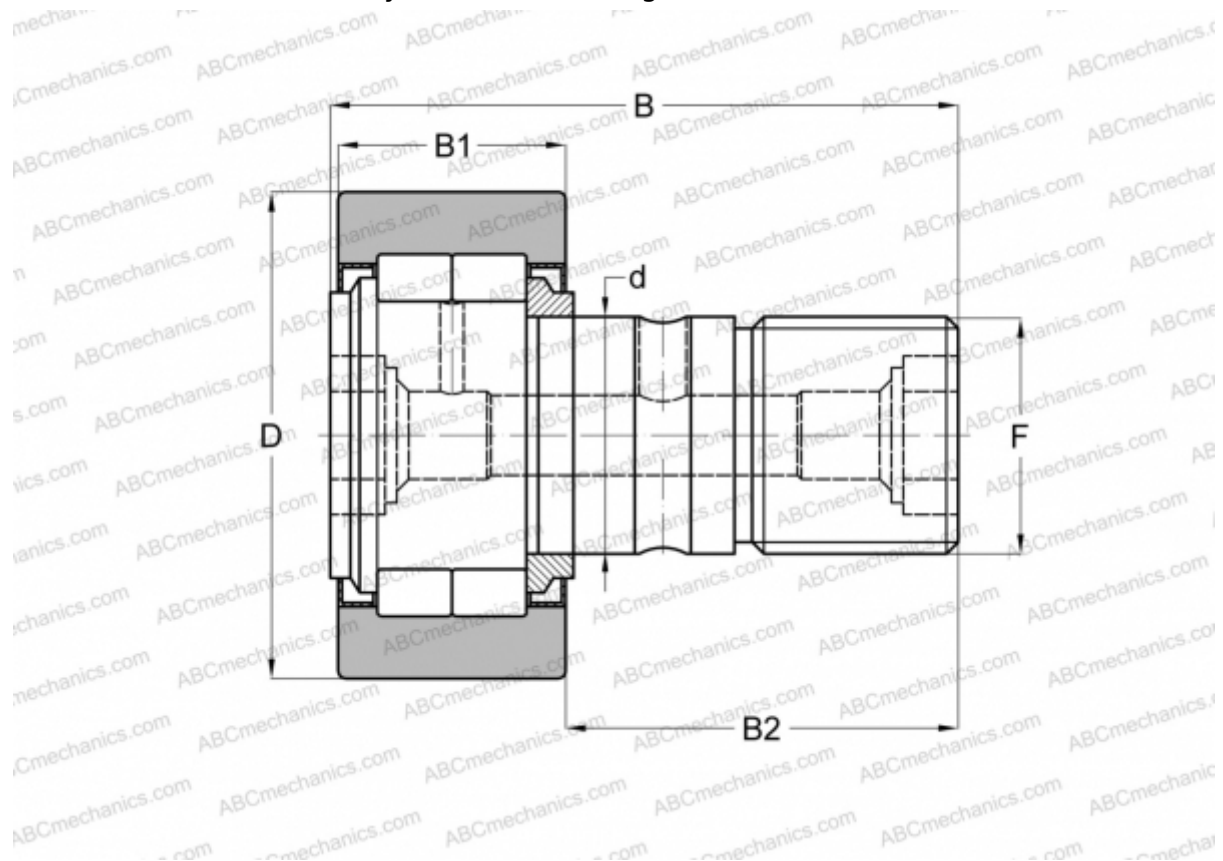

Technical specification

DIMENSIONS, MM

d	18,000
D	40,000
B	58,000
B1	20,000
B2	36,500
F	M18x1,5

WEIGHT, KG 0,254

MANUFACTURER [McGill](#)

INTERCHANGE

ABC	NUKR 40 X
FAG	NUKR 40 C DZ(NUKD40 DZ)
INA	NUKR 40 X
IKO	NUCF 18

INTERCHANGE

SKF [NUKR 40 XA](#)