

NUKR 72 X INA

Cam followers

TYPE: Roller bearings, Stud type track rollers, With axial guidance, full complement cylindrical roller set, labyrinth seals on both sides, cylindrical outer ring

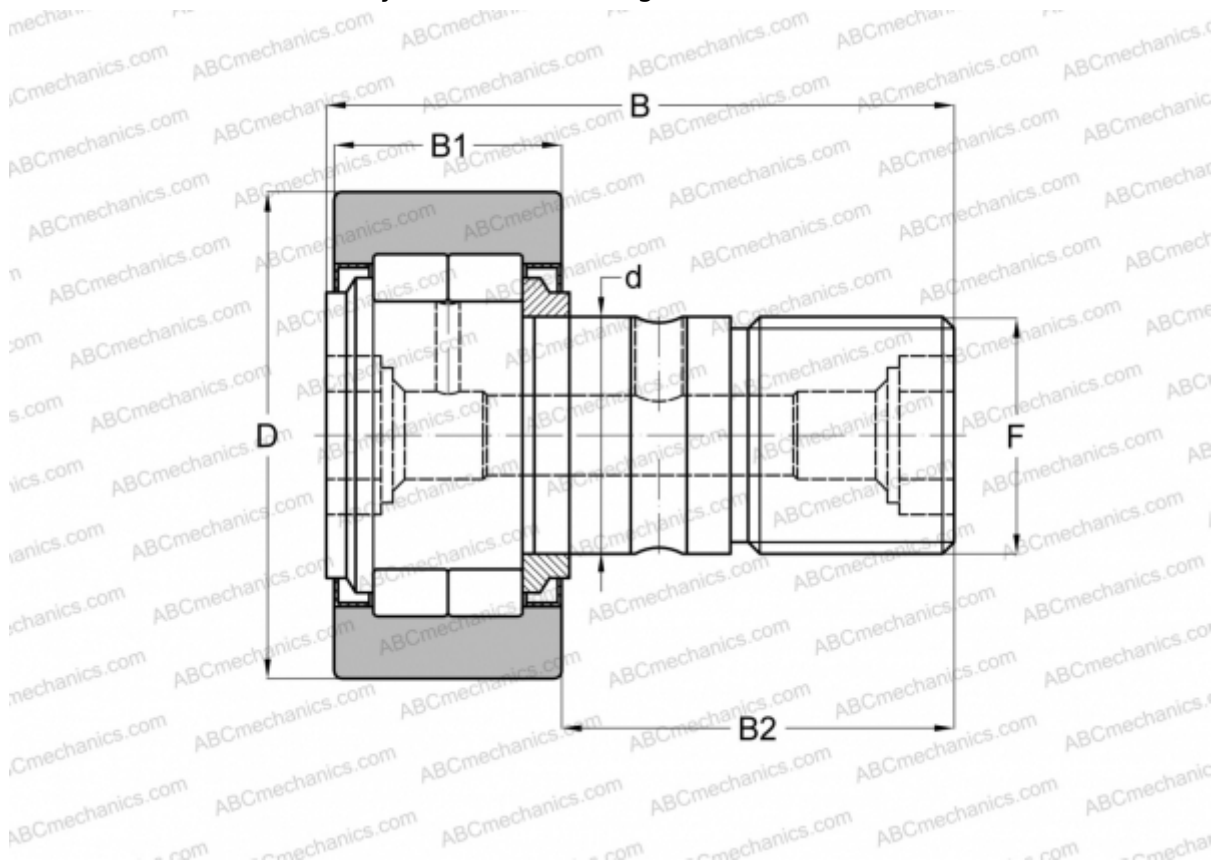

Technical specification

DIMENSIONS, MM

d	24,000
D	72,000
B	80,000
B1	29,000
B2	49,500
F	M24x1,5

WEIGHT, KG 1,043

MANUFACTURER [INA](#)

INTERCHANGE

ABC	NUKR 72 X
FAG	NUKR 72 C DZ(NUKD72 DZ)
IKO	NUCF 24-1
McGill	MCFD 72 SX

INTERCHANGE

SKF [NUKR 72 XA](#)