

## KRE 16 PPX SKF

Cam followers

TYPE: Roller bearings, Stud type track rollers, With axial guidance, with eccentric collar, sealing rings on both sides, cylindrical outer ring

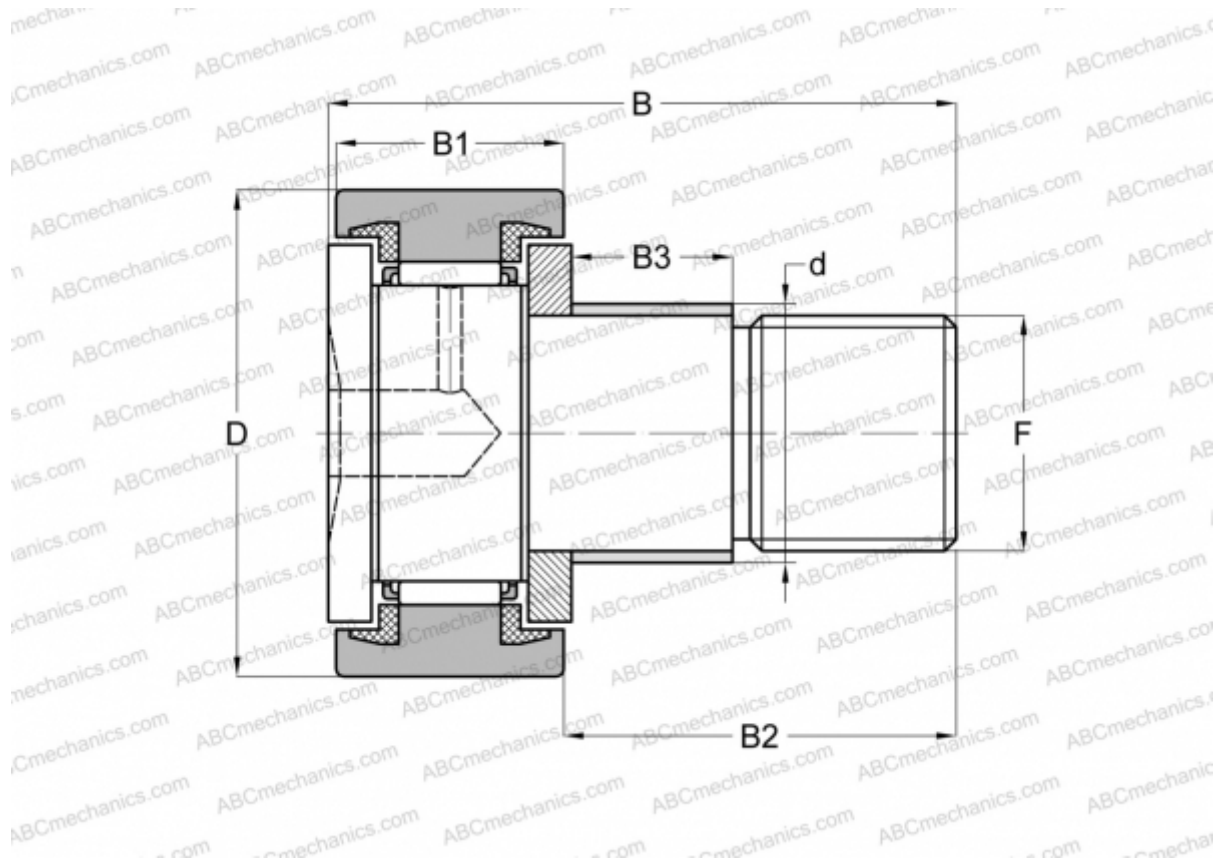

### Technical specification

#### DIMENSIONS, MM

d	9,000
D	16,000
B	28,000
B1	11,000
B2	16,000
F	M6

**WEIGHT, KG** 0,020

**MANUFACTURER** [SKF](#)

#### INTERCHANGE

ABC	<a href="#">KRE 16 PPX</a>
INA	<a href="#">KRE 16 PPX</a>
IKO	<a href="#">CFE 6 UU</a>

#### CALCULATION DATA

Basic dynamic load rating, C	3,140 kN
Basic static load rating, Co	3,200 kN
Fatigue load limit, Pu	0,345 kN
Limiting speed	6000 r/min