

## KRE 32 PPX INA

Cam followers

TYPE: Roller bearings, Stud type track rollers, With axial guidance, with eccentric collar, sealing rings on both sides, cylindrical outer ring

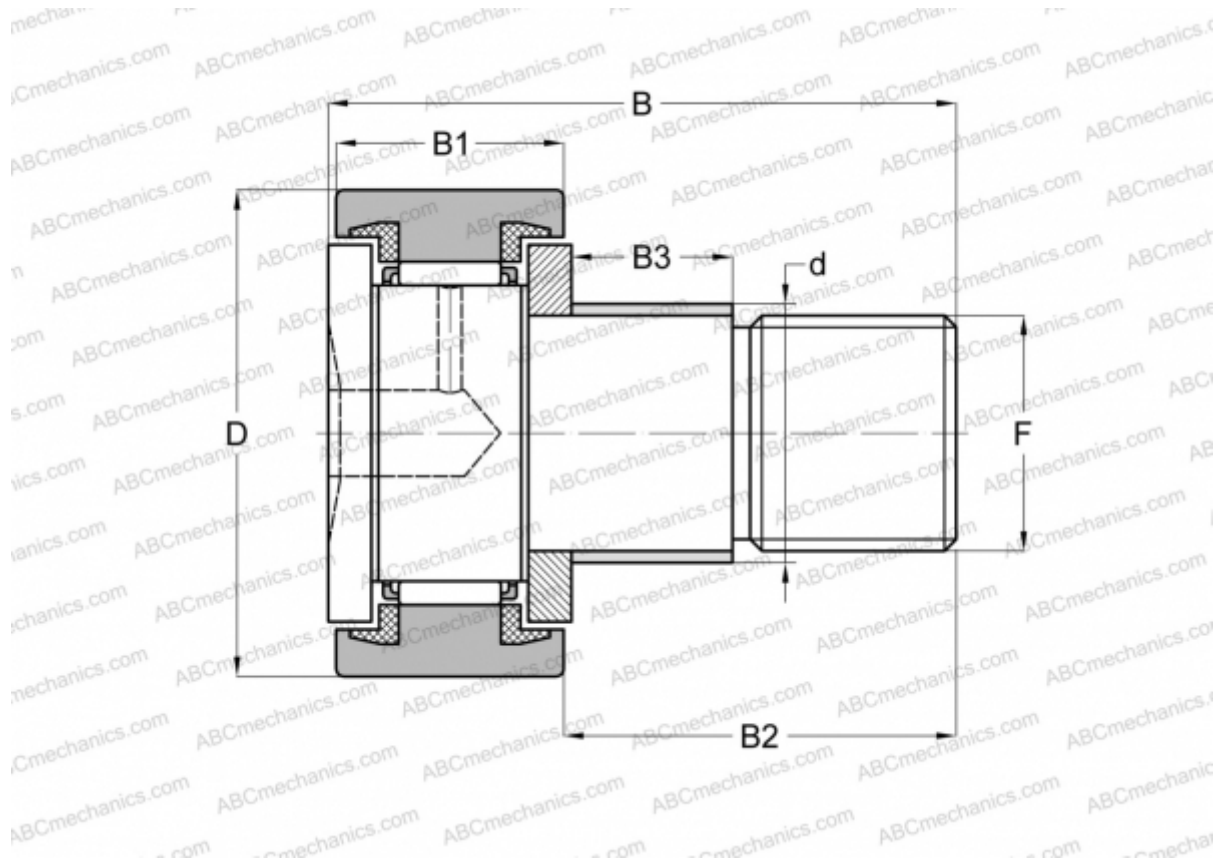

### Technical specification

#### DIMENSIONS, MM

d	15,000
D	32,000
B	40,000
B1	14,000
B2	25,000
B3	11,000
F	M12x1,5

**WEIGHT, KG** 0,104

**MANUFACTURER** [INA](#)

#### INTERCHANGE

ABC	<a href="#">KRE 32 PPX</a>
SKF	<a href="#">KRE 32 PPX</a>