

## KRE 35 PPX INA

Cam followers

TYPE: Roller bearings, Stud type track rollers, With axial guidance, with eccentric collar, sealing rings on both sides, cylindrical outer ring

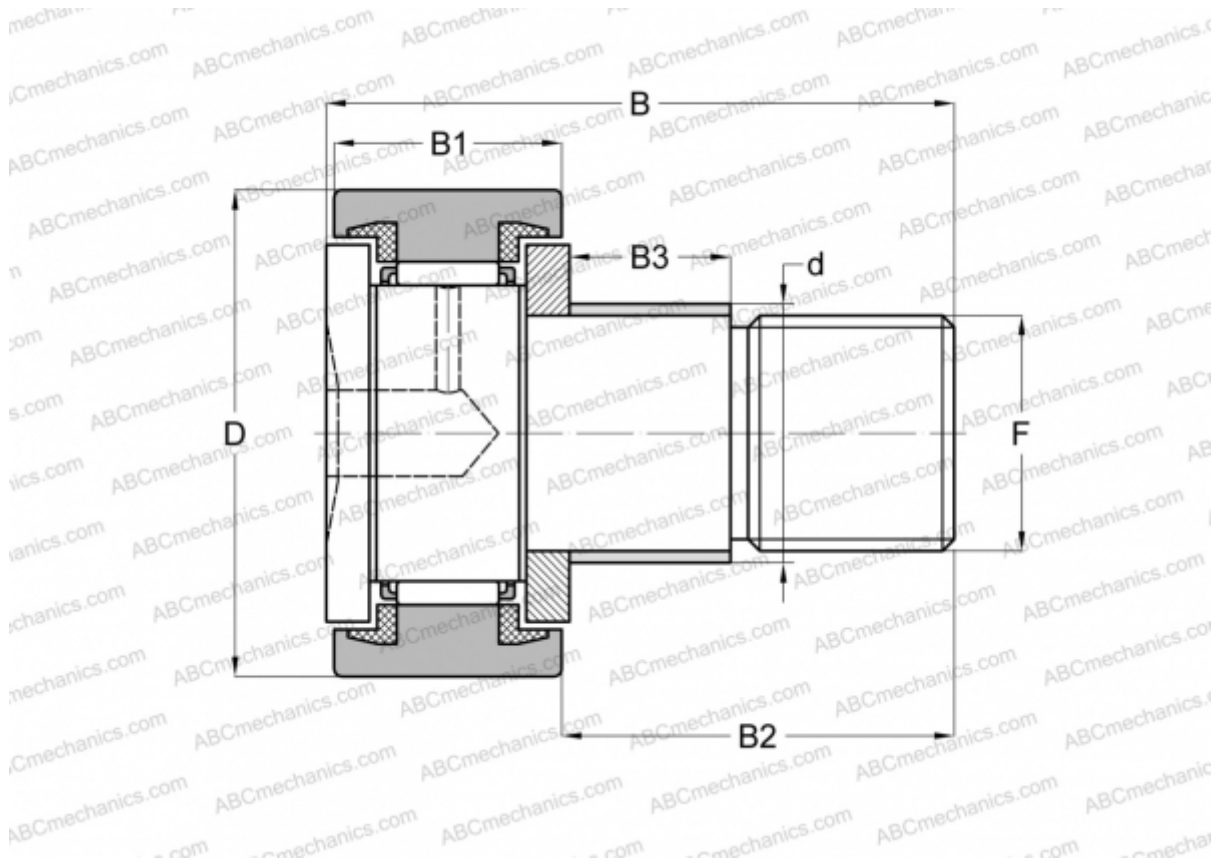

### Technical specification

#### DIMENSIONS, MM

d	20,000
D	35,000
B	52,000
B1	18,000
B2	32,500
B3	14,000
F	M16x1,5

**WEIGHT, KG** 0,177

**MANUFACTURER** [INA](#)

#### INTERCHANGE

ABC	<a href="#">KRE 35 PPX</a>
SKF	<a href="#">KRE 35 PPX</a>