

KRE 40 PPX SKF

Cam followers

TYPE: Roller bearings, Stud type track rollers, With axial guidance, with eccentric collar, sealing rings on both sides, cylindrical outer ring

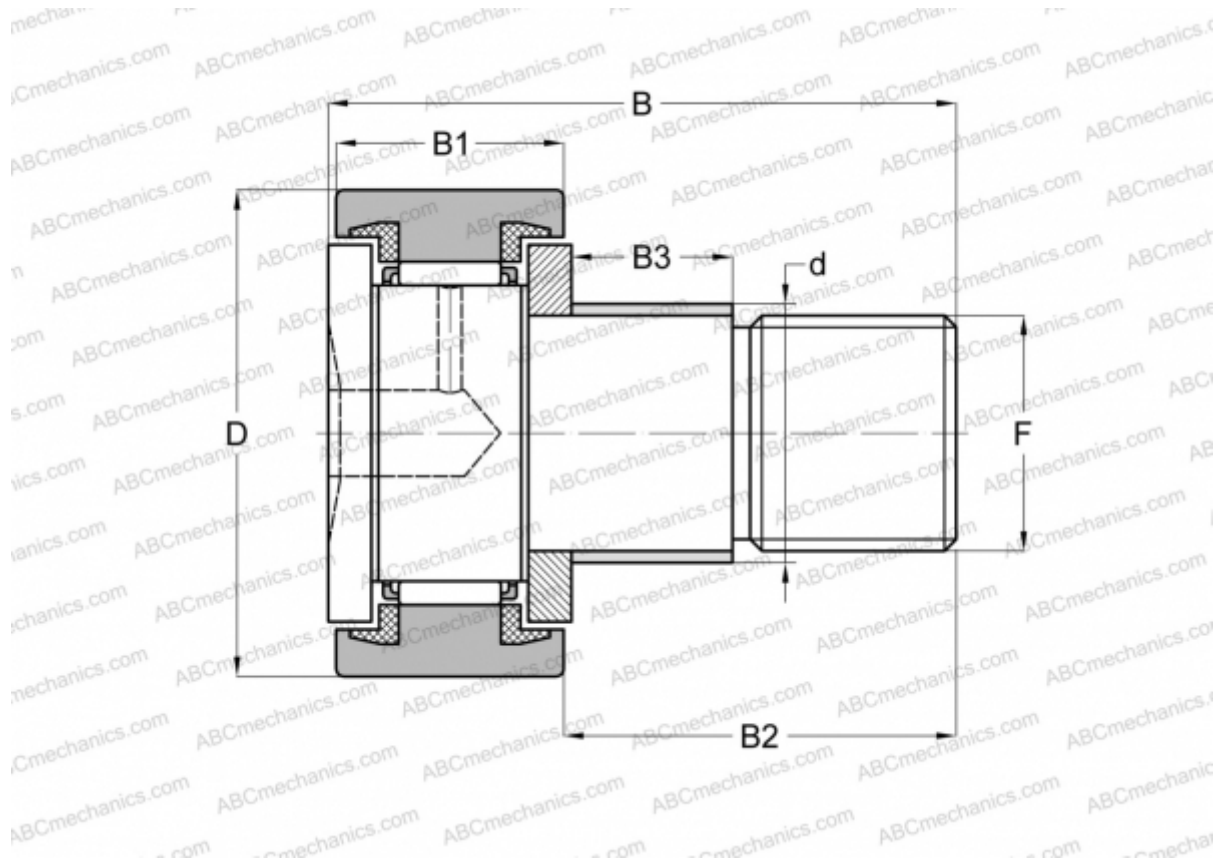

Technical specification

DIMENSIONS, MM

d	22,000
D	40,000
B	58,000
B1	20,000
B2	36,500
F	M 18x1.5

WEIGHT, KG 0,255

MANUFACTURER [SKF](#)

INTERCHANGE

ABC	KRE 40 PPX
INA	KRE 40 PPX

CALCULATION DATA

Basic dynamic load rating, C	10,500 kN
------------------------------	-----------

CALCULATION DATA

Basic static load rating, Co	14,600 kN
Fatigue load limit, Pu	1,730 kN
Limiting speed	3400 r/min