

KRE 47 PPX SKF

Cam followers

TYPE: Roller bearings, Stud type track rollers, With axial guidance, with eccentric collar, sealing rings on both sides, cylindrical outer ring

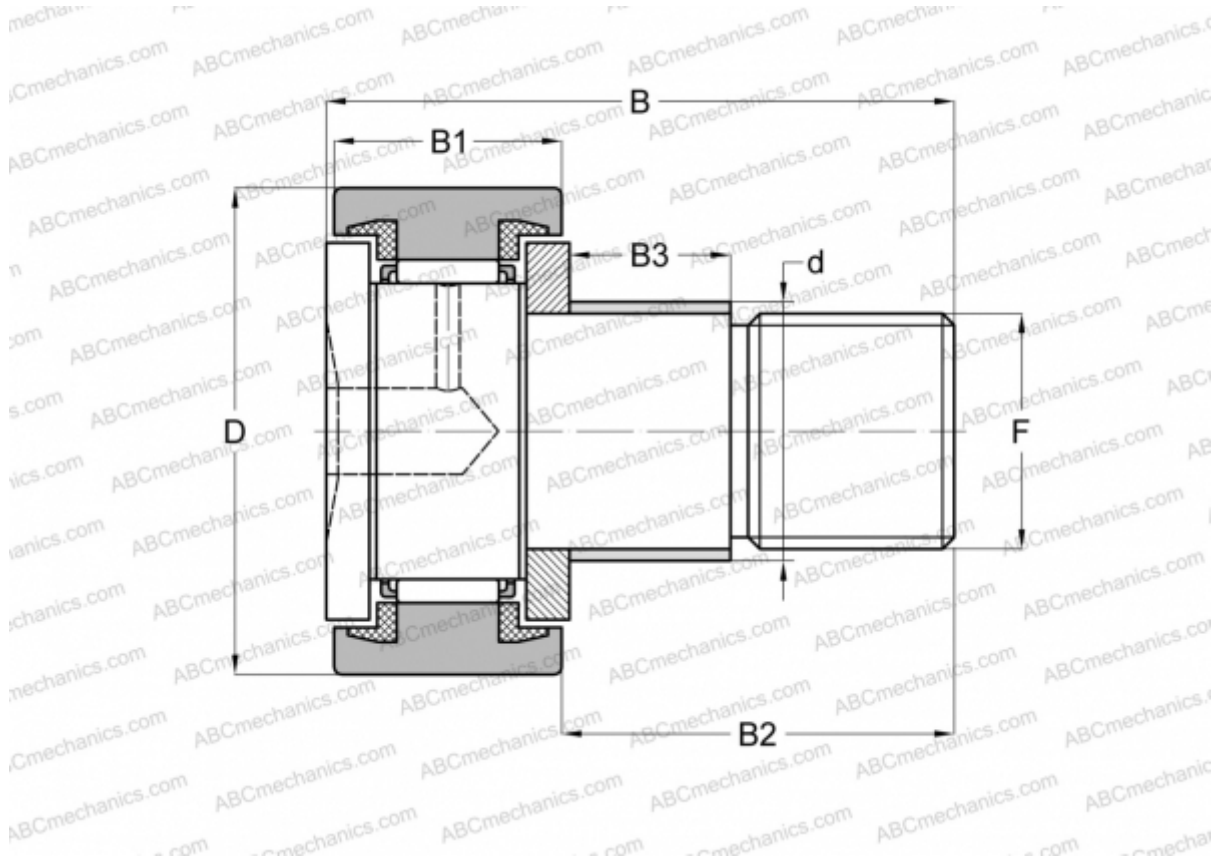

Technical specification

DIMENSIONS, MM

d	24,000
D	47,000
B	66,000
B1	24,000
B2	40,500
F	M 20x1.5

WEIGHT, KG 0,400

MANUFACTURER [SKF](#)

INTERCHANGE

ABC	KRE 47 PPX
INA	KRE 47 PPX

CALCULATION DATA

Basic dynamic load rating, C	14,700 kN
------------------------------	-----------

CALCULATION DATA

Basic static load rating, Co	24,500 kN
Fatigue load limit, Pu	2,900 kN
Limiting speed	3000 r/min