

## KRE 52 PPX INA

Cam followers

TYPE: Roller bearings, Stud type track rollers, With axial guidance, with eccentric collar, sealing rings on both sides, cylindrical outer ring

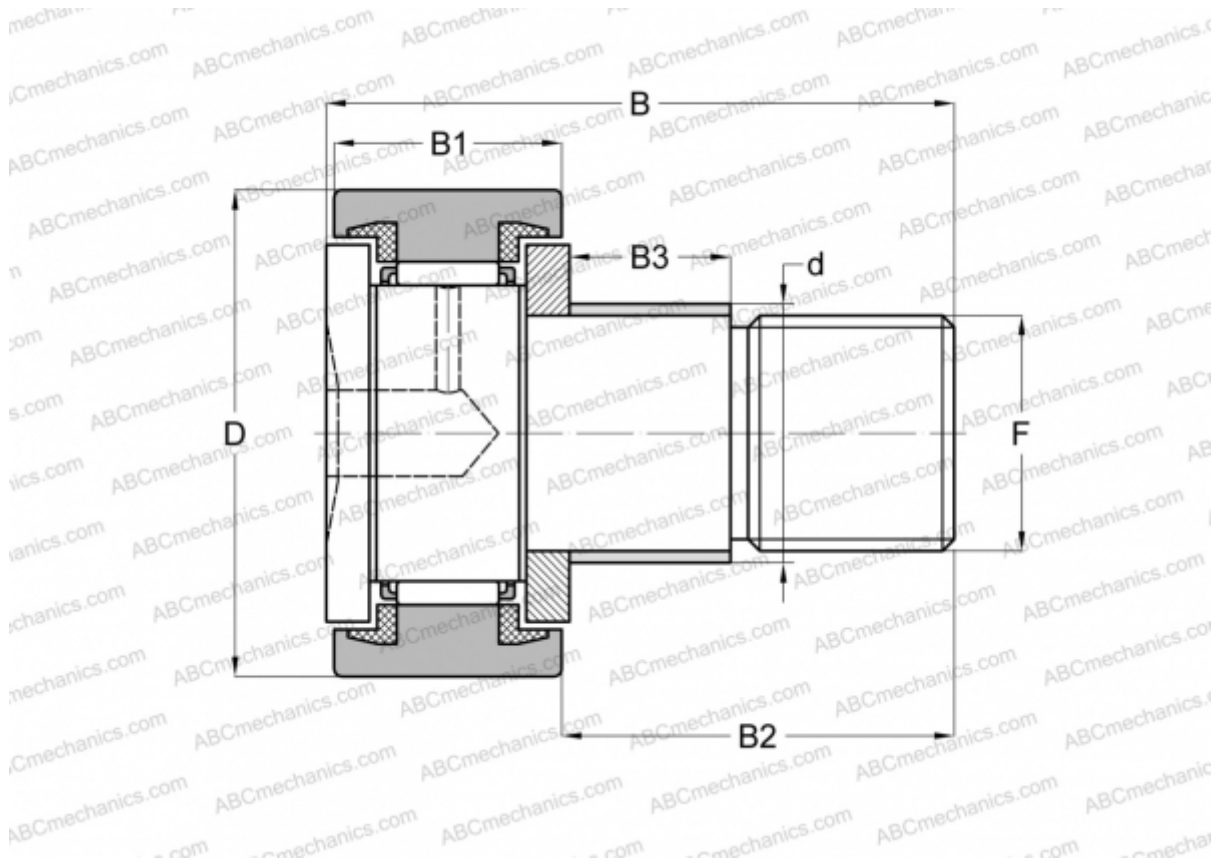

### Technical specification

#### DIMENSIONS, MM

d	24,000
D	52,000
B	66,000
B1	24,000
B2	40,500
B3	18,000
F	M20x1,5

**WEIGHT, KG** 0,473

**MANUFACTURER** [INA](#)

#### INTERCHANGE

ABC	<a href="#">KRE 52 PPX</a>
SKF	<a href="#">KRE 52 PPX</a>