

KRE 90 PPX SKF

Cam followers

TYPE: Roller bearings, Stud type track rollers, With axial guidance, with eccentric collar, sealing rings on both sides, cylindrical outer ring

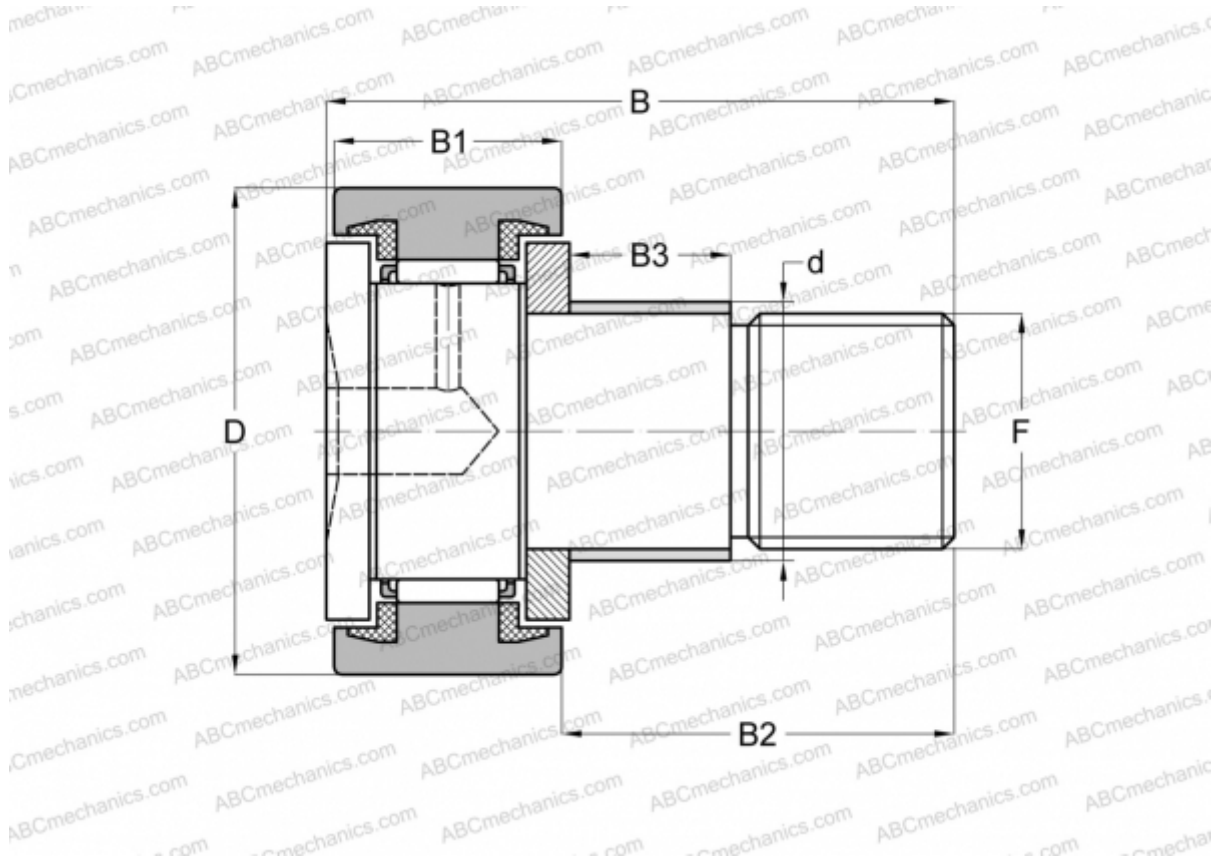

Technical specification

DIMENSIONS, MM

d	35,000
D	90,000
B	100,000
B1	35,000
B2	63,000
F	M 30x1.5

WEIGHT, KG 2,032

MANUFACTURER [SKF](#)

INTERCHANGE

ABC	KRE 90 PPX
INA	KRE 90 PPX

CALCULATION DATA

Basic dynamic load rating, C	38,000 kN
------------------------------	-----------

CALCULATION DATA

Basic static load rating, Co	76,500 kN
Fatigue load limit, Pu	9,500 kN
Limiting speed	1800 r/min