

NUKRE 35 C FAG

Cam followers

TYPE: Roller bearings, Stud type track rollers, With axial guidance, full complement cylindrical roller set, with eccentric collar, labyrinth seals on both sides

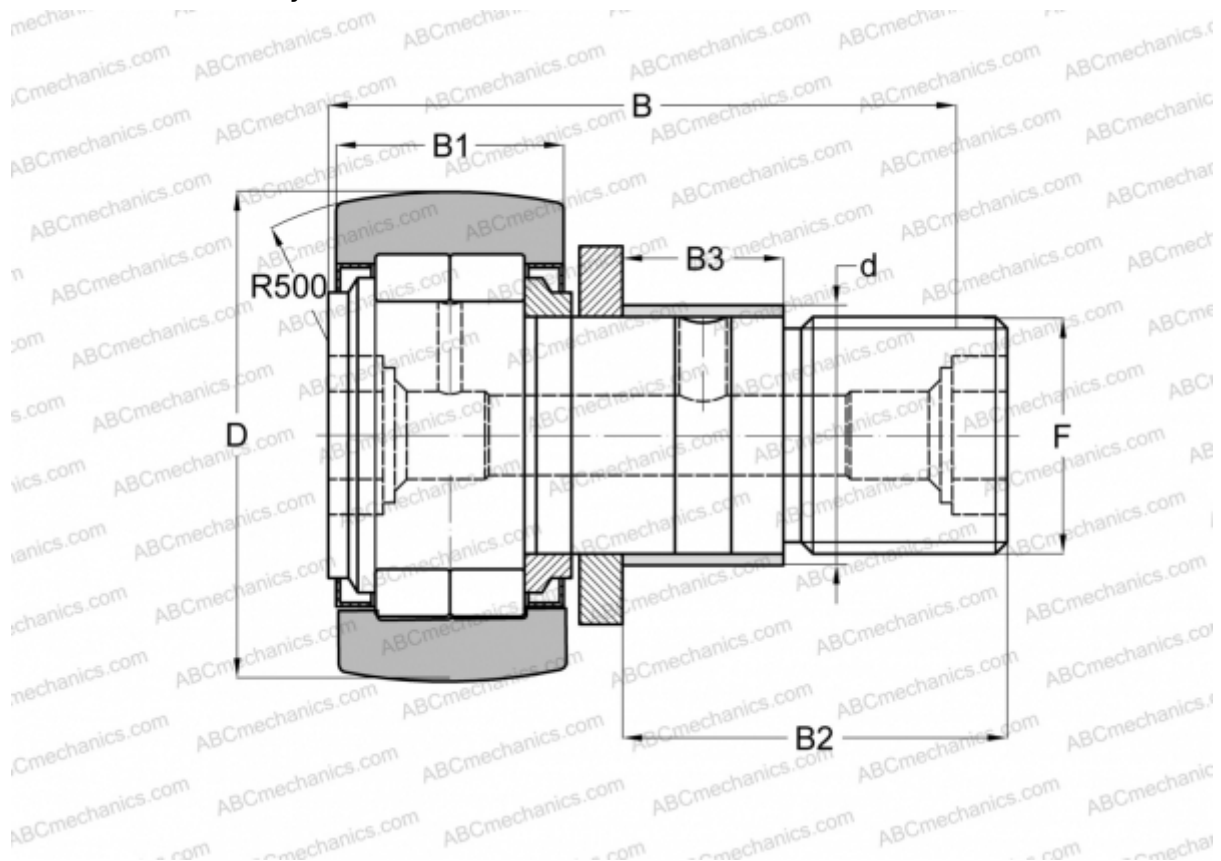

Technical specification

DIMENSIONS, MM

d	20,000
D	35,000
B	52,000
B1	18,000
B2	32,500
B3	14,000
F	M16x1,5

WEIGHT, KG 0,177

MANUFACTURER [FAG](#)

INTERCHANGE

ABC	NUKRE 35
INA	NUKRE 35
SKF	NUKRE 35 A