

## NUKRE 47 ABC

Cam followers

TYPE: Roller bearings, Stud type track rollers, With axial guidance, full complement cylindrical roller set, with eccentric collar, labyrinth seals on both sides

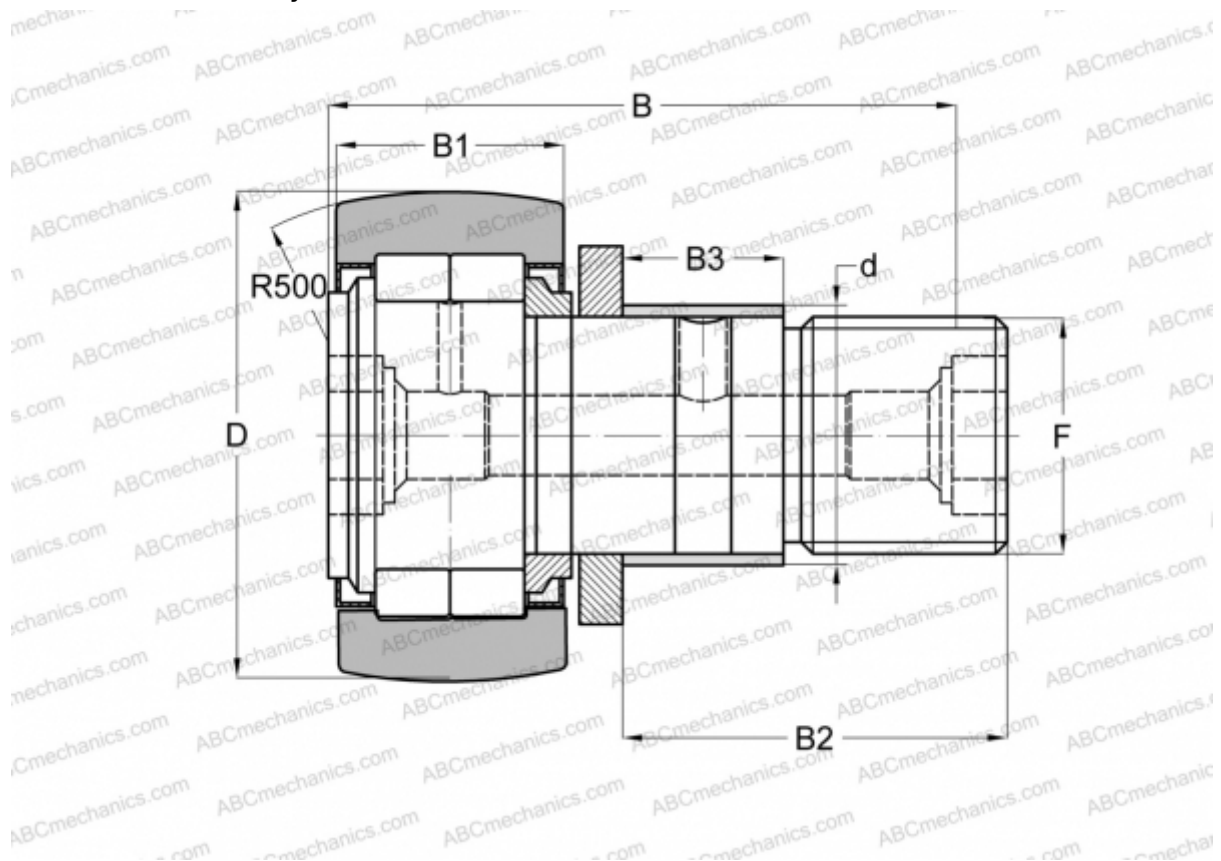

### Technical specification

#### DIMENSIONS, MM

d	24,000
D	47,000
B	66,000
B1	24,000
B2	40,500
B3	18,000
F	M20x1,5

**WEIGHT, KG** 0,399

**MANUFACTURER** [ABC](#)

#### INTERCHANGE

FAG	<a href="#">NUKRE 47 C</a>
INA	<a href="#">NUKRE 47</a>
SKF	<a href="#">NUKRE 47 A</a>