

## NUKRE 52 C FAG

Cam followers

TYPE: Roller bearings, Stud type track rollers, With axial guidance, full complement cylindrical roller set, with eccentric collar, labyrinth seals on both sides

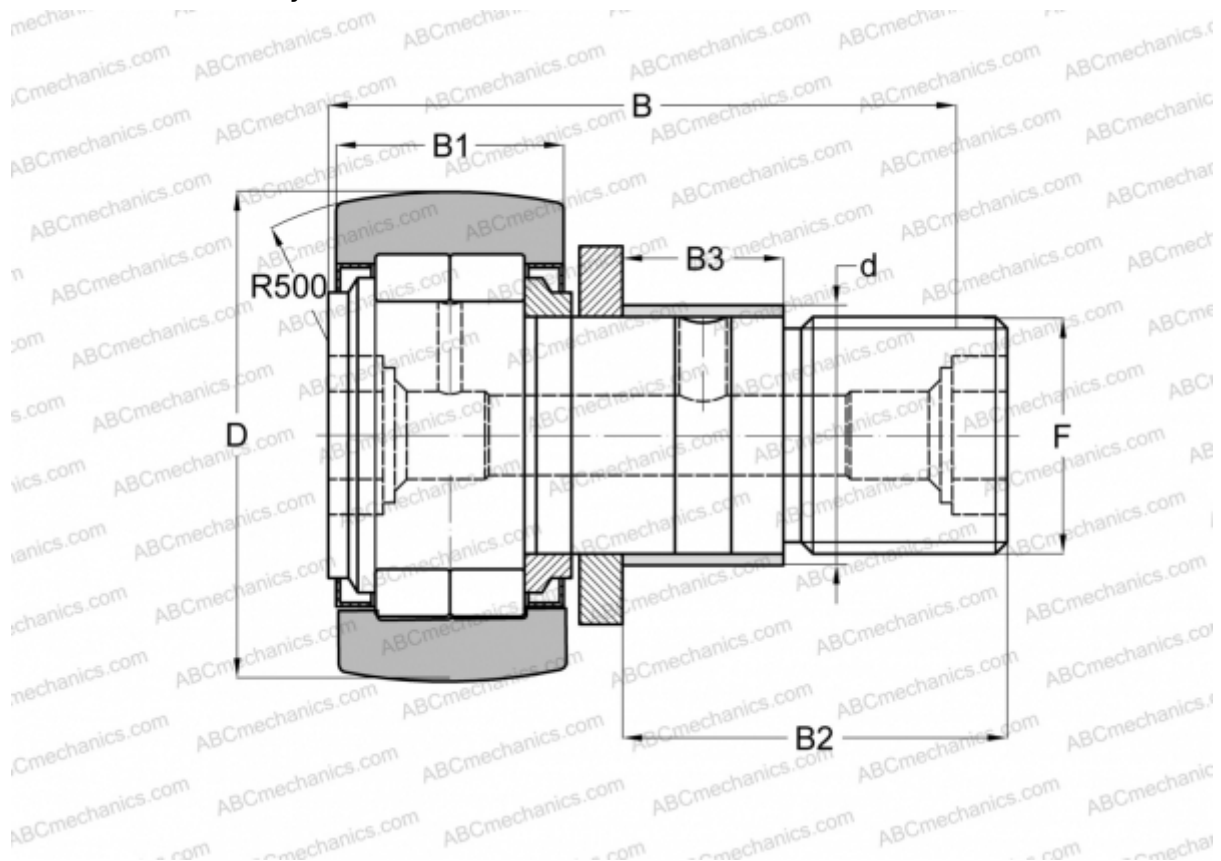

### Technical specification

#### DIMENSIONS, MM

d	24,000
D	52,000
B	66,000
B1	24,000
B2	40,500
B3	18,000
F	M20x1,5

**WEIGHT, KG** 0,472

**MANUFACTURER** [FAG](#)

#### INTERCHANGE

ABC	<a href="#">NUKRE 52</a>
INA	<a href="#">NUKRE 52</a>
SKF	<a href="#">NUKRE 52 A</a>