

NUKRE 90 C FAG

Cam followers

TYPE: Roller bearings, Stud type track rollers, With axial guidance, full complement cylindrical roller set, with eccentric collar, labyrinth seals on both sides

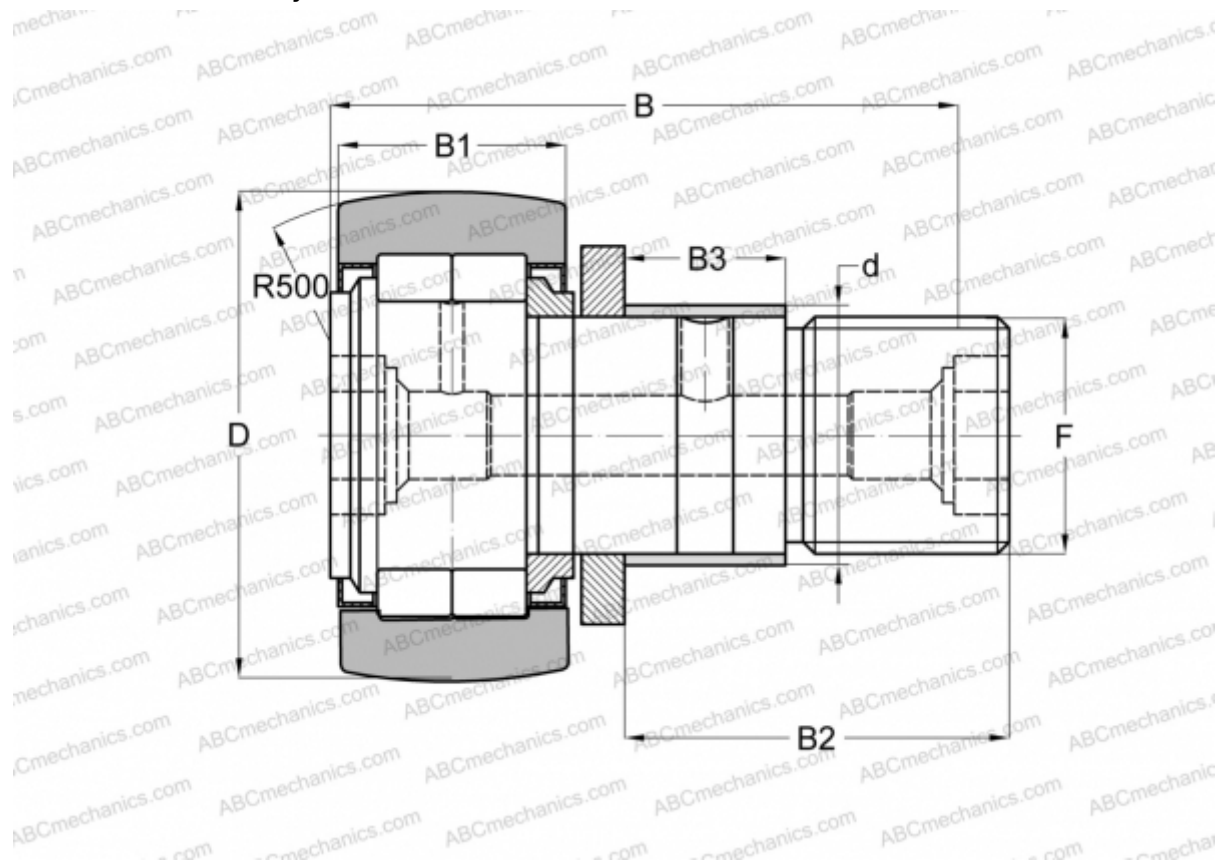

Technical specification

DIMENSIONS, MM

d	35,000
D	90,000
B	100,000
B1	35,000
B2	63,000
B3	29,000
F	M30x1,5

WEIGHT, KG 2,018

MANUFACTURER [FAG](#)

INTERCHANGE

ABC	NUKRE 90
INA	NUKRE 90
SKF	NUKRE 90 A