

NUKRE 40 X ABC

Cam followers

TYPE: Roller bearings, Stud type track rollers, With axial guidance, full complement cylindrical roller set, with eccentric collar, labyrinth seals on both sides, cylindrical outer ring

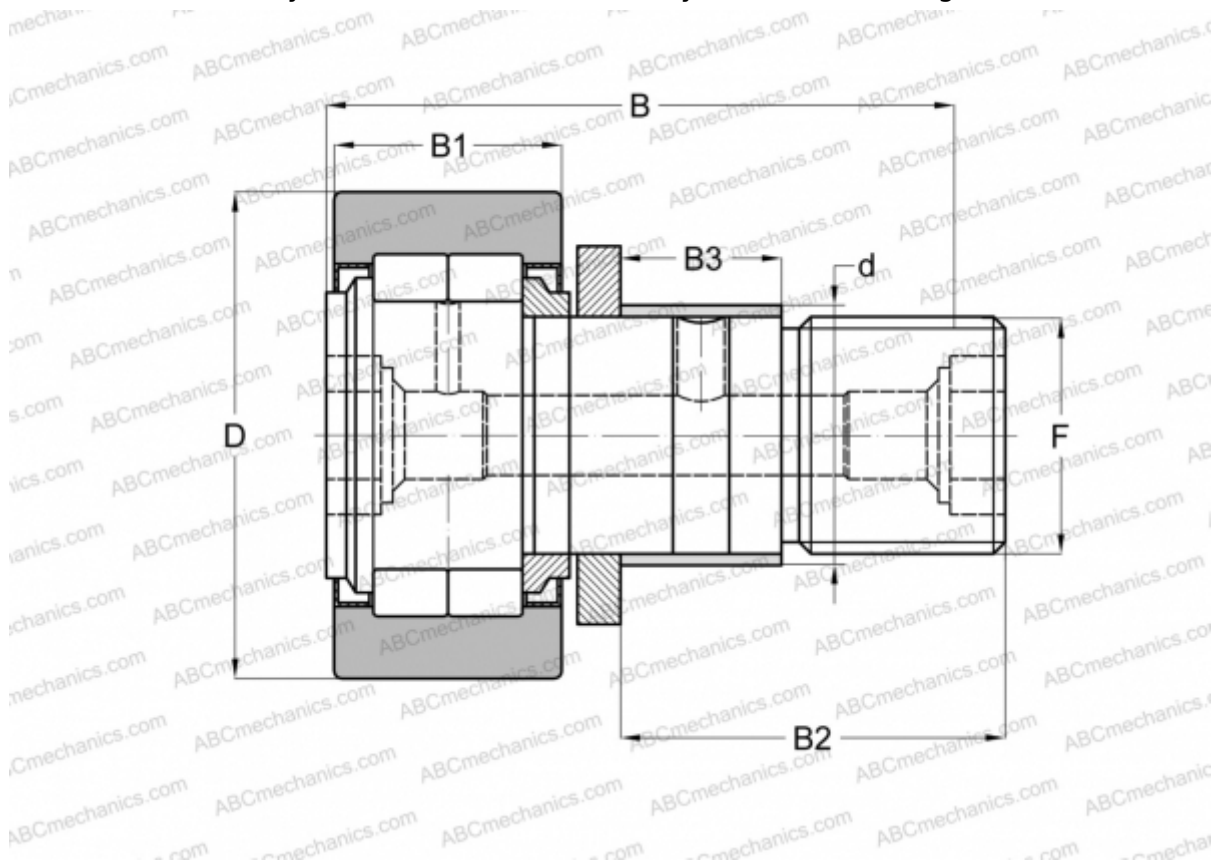

Technical specification

DIMENSIONS, MM

d	22,000
D	40,000
B	58,000
B1	20,000
B2	36,500
B3	16,000
F	M18x1,5

WEIGHT, KG 0,259

MANUFACTURER [ABC](#)

INTERCHANGE

FAG	NUKRE 40 C DZ
INA	NUKRE 40 X
SKF	NUKRE 40 X